



Concentric Technology Solutions Inc

Solutions for the Wireless Industry

TC-93060A/93061A

Antenna Coupler

Data Sheet



TC-93060A

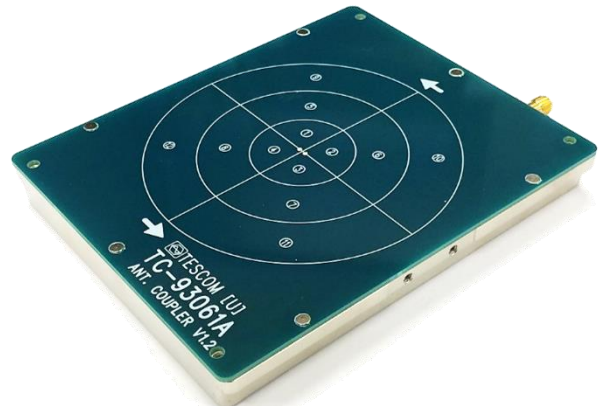

TC-93061A

Mechanical Specifications

Frequency Range	700 – 7500 MHz
RF Connector	SMA (f)
Dimension	106 (W) x 130 (D) x 15.6 (H) mm
Weight	300 g
Terminal	50 ohm
VSWR	Better than 1:2.2 (Typ. 1.8)
Polarization	TC-93060A (LHCP), TC-93061A (RHCP)

Dimensions

TC-93060A

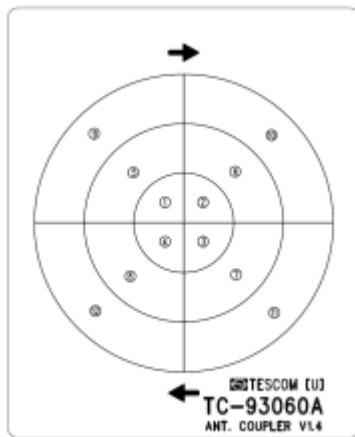
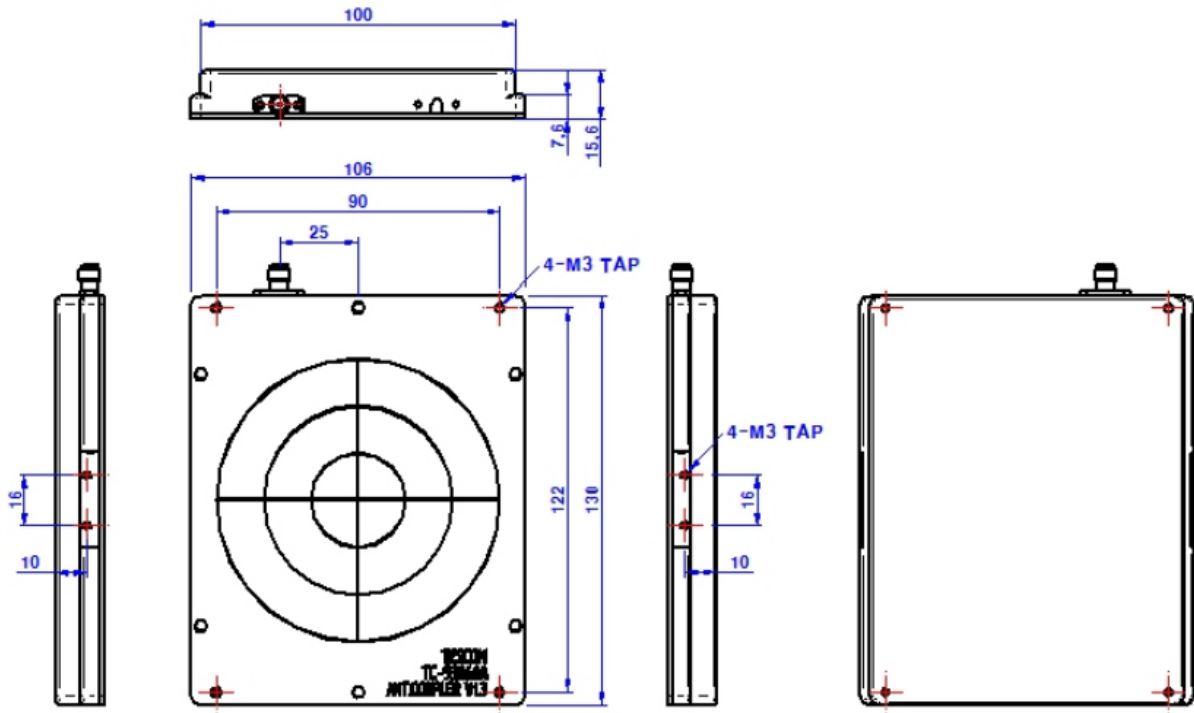

TC-93060A

Dimensions

TC-93061A

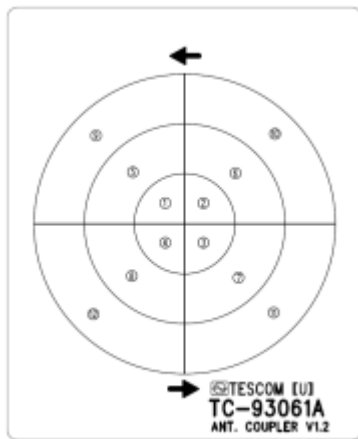
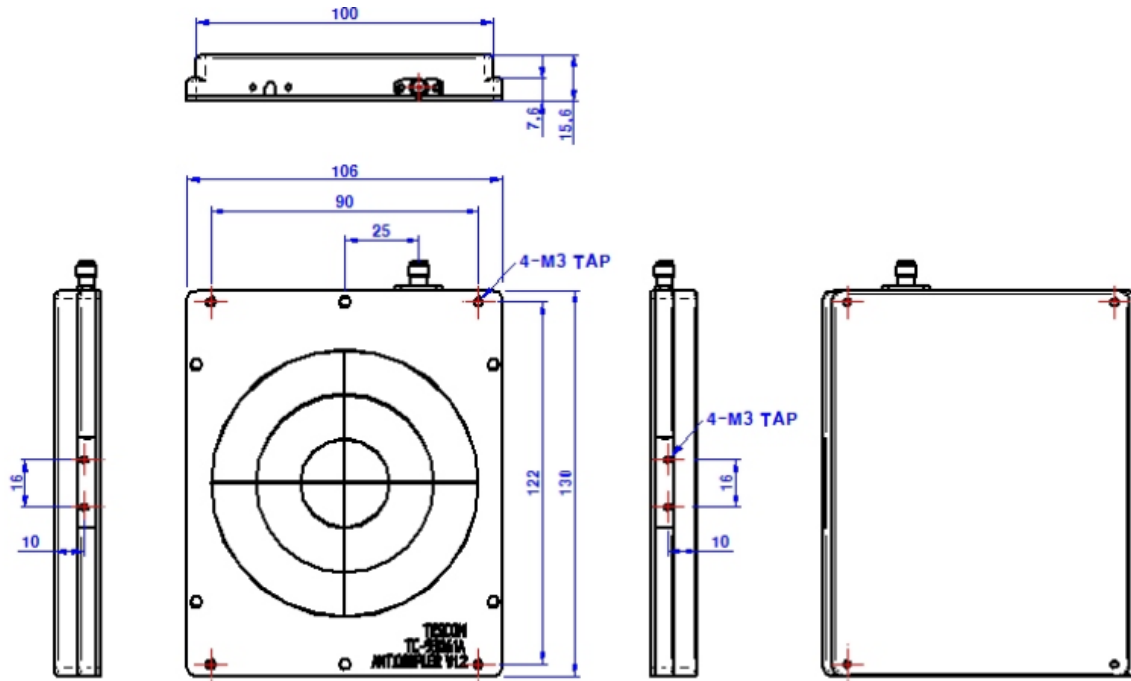

TC-93061A

Typical VSWR Data of TC-93060A/93061A (T=25°C)

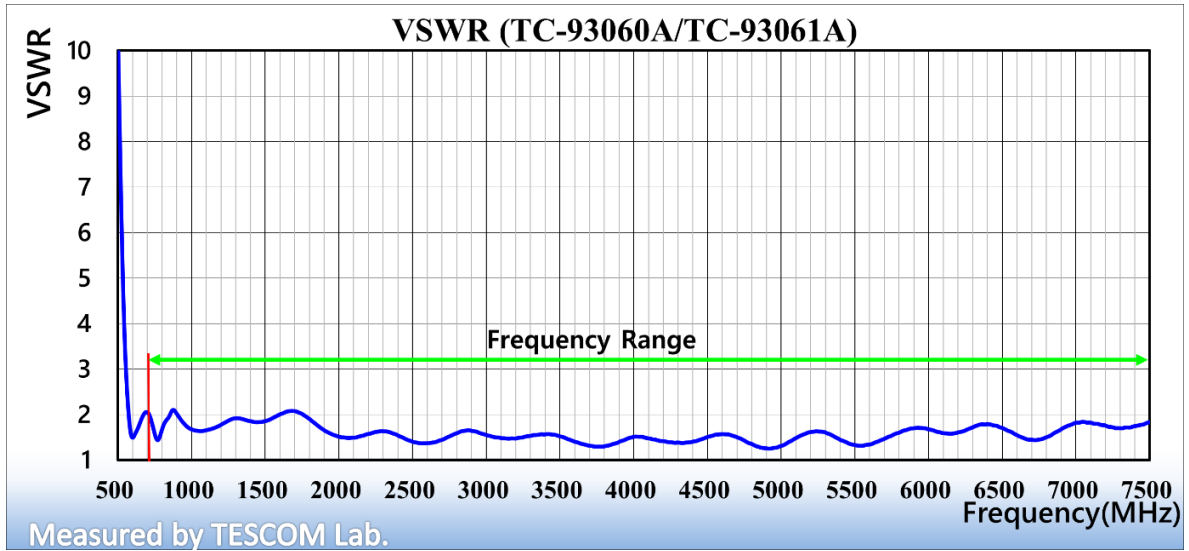

Polarization of TC-93060A/93061A

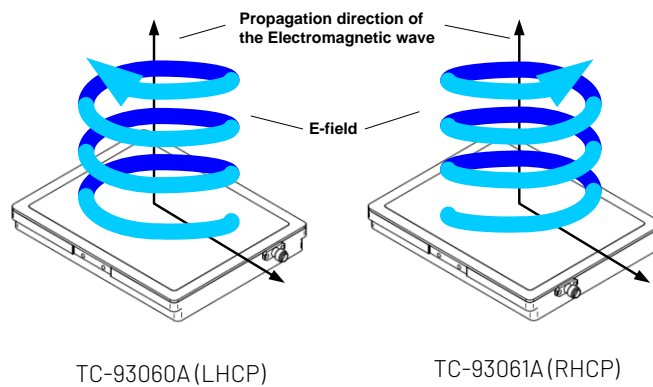

Transfer function difference of between TC-93060A/93061A

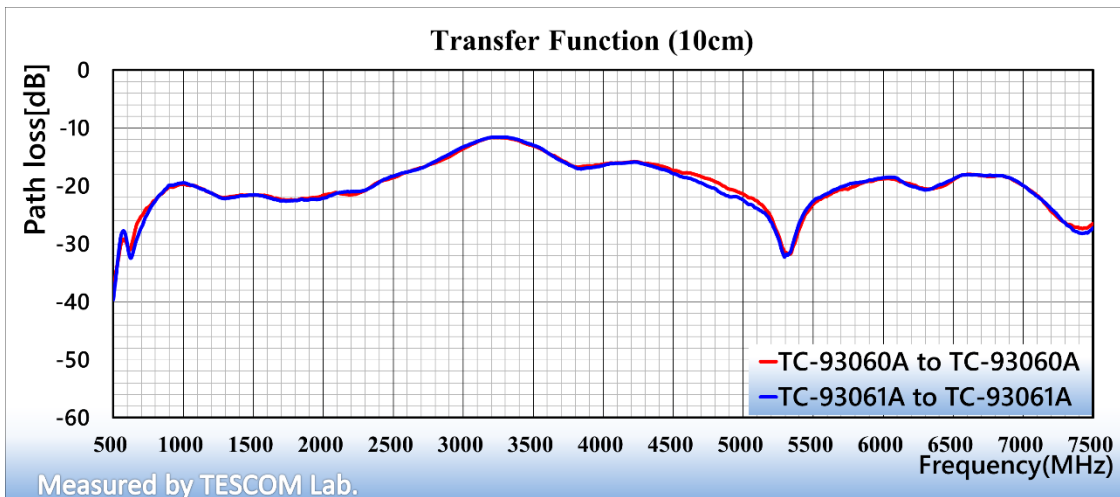
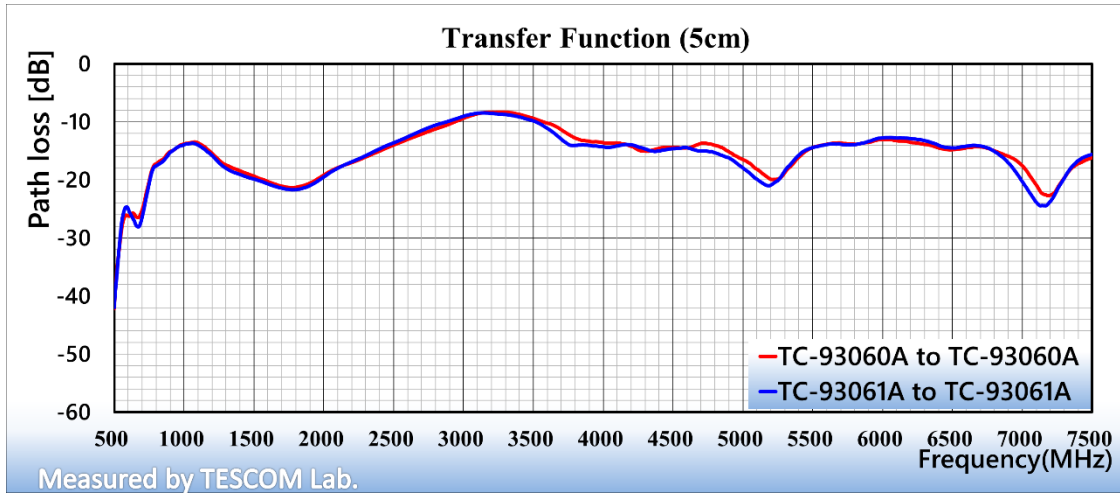
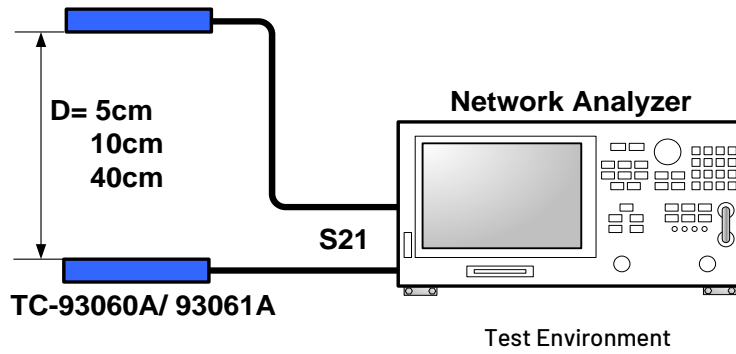

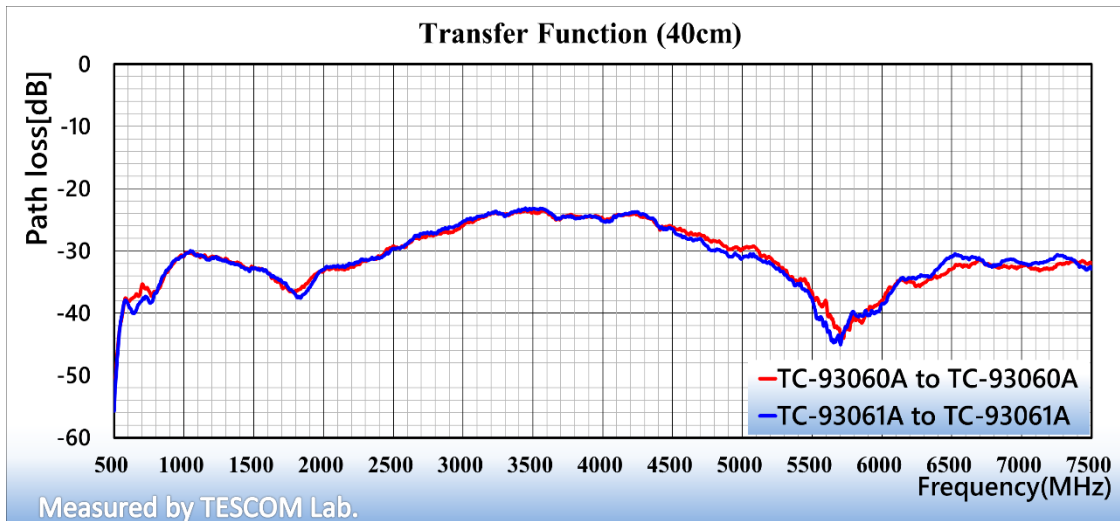

Field Distribution of TC-93060A/93061A

Measured in open area through Dipole Antenna (0.9 & 1.8 & 2.4 & 5.8 GHz, Tescom)

Distance from Antenna Coupler (TC-93060A/93061A) to Dipole Antenna: 5 cm

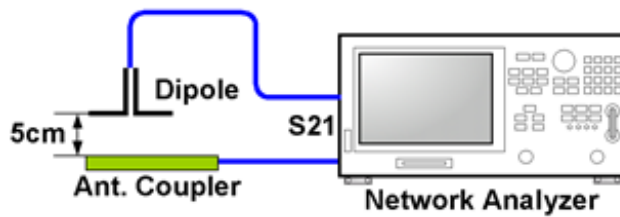

Environment setup for measuring Field distribution

Z

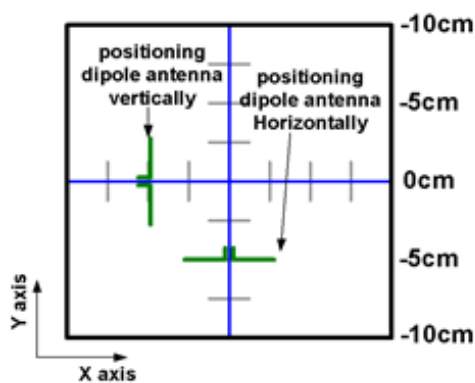

Positioning Dipole Antenna

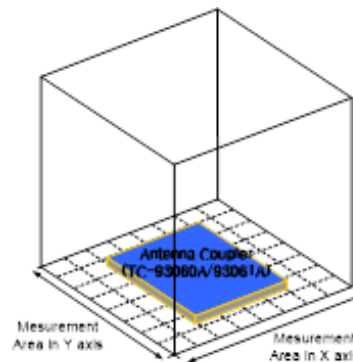

Antenna Coupler Setup

Path Loss Distribution at 900 MHz

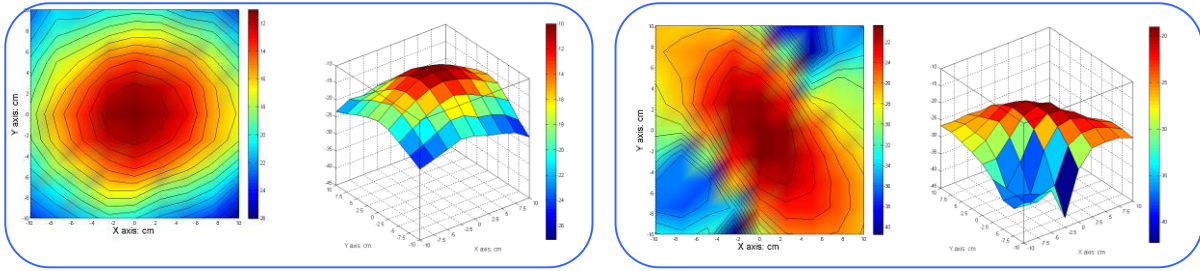

TC-93060A (Left: Dipole Antenna Horizontally: Dipole Antenna Vertically)

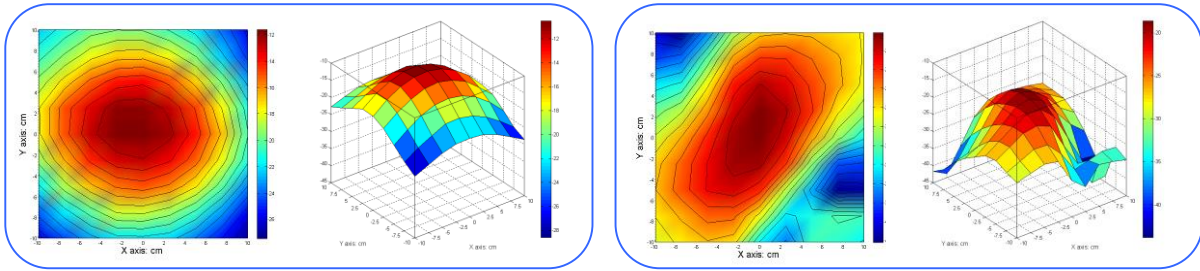

TC-93061A (Left: Dipole Antenna Horizontally: Dipole Antenna Vertically)

Path Loss Distribution at 1800 MHz

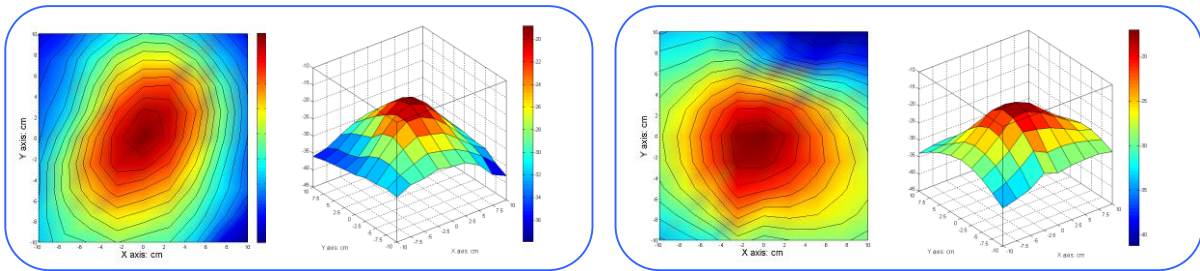

TC-93060A (Left: Dipole Antenna Horizontally: Dipole Antenna Vertically)

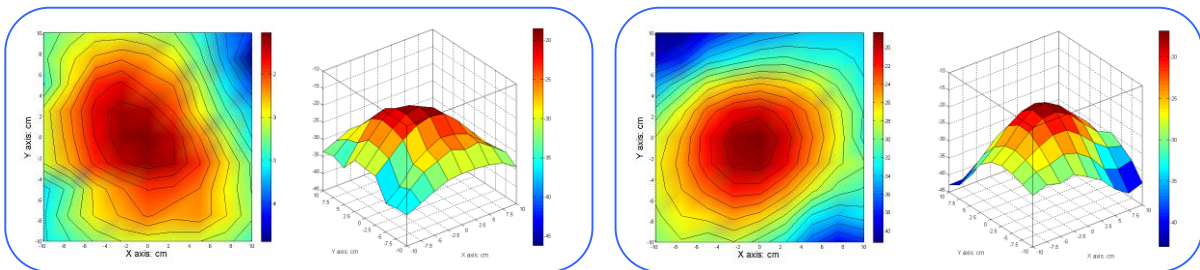

TC-93061A (Left: Dipole Antenna Horizontally: Dipole Antenna Vertically)

Path Loss Distribution at 2400 MHz

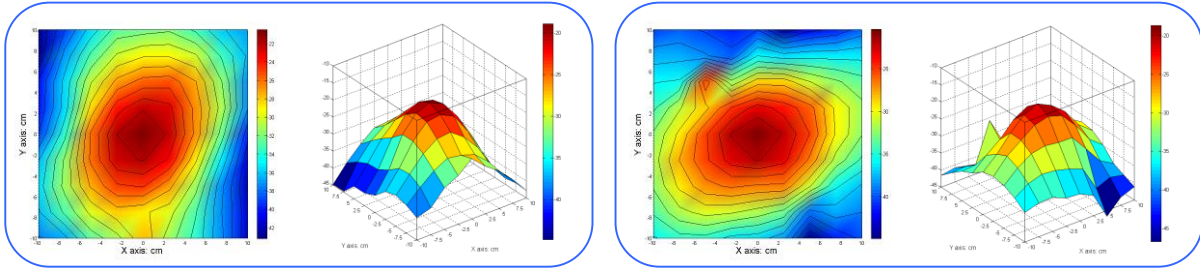

TC-93060A (Left: Dipole Antenna Horizontally: Dipole Antenna Vertically)

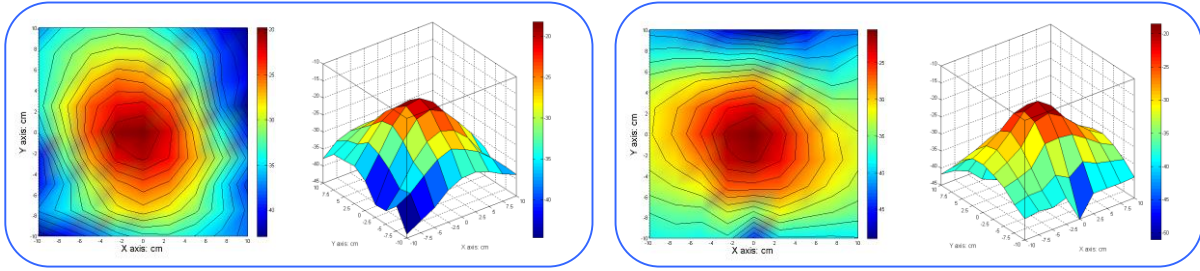

TC-93061A (Left: Dipole Antenna Horizontally: Dipole Antenna Vertically)

Path Loss Distribution at 5800 MHz

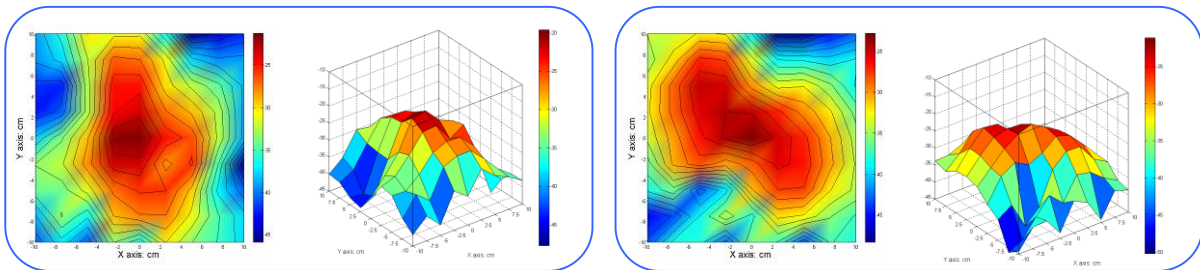

TC-93060A (Left: Dipole Antenna Horizontally: Dipole Antenna Vertically)

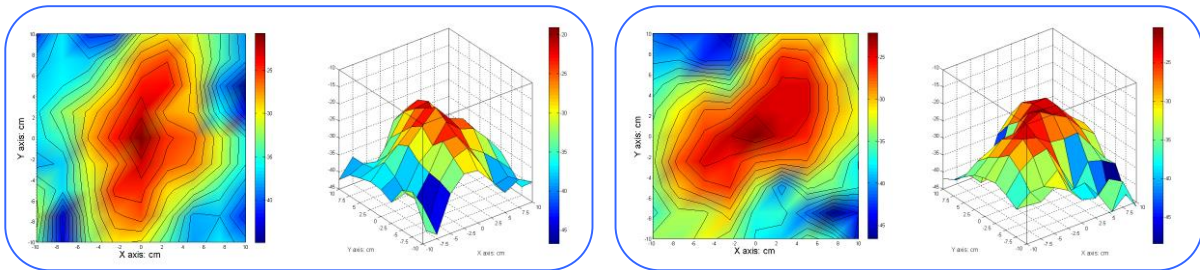

TC-93061A (Left: Dipole Antenna Horizontally: Dipole Antenna Vertically)

Antenna gain

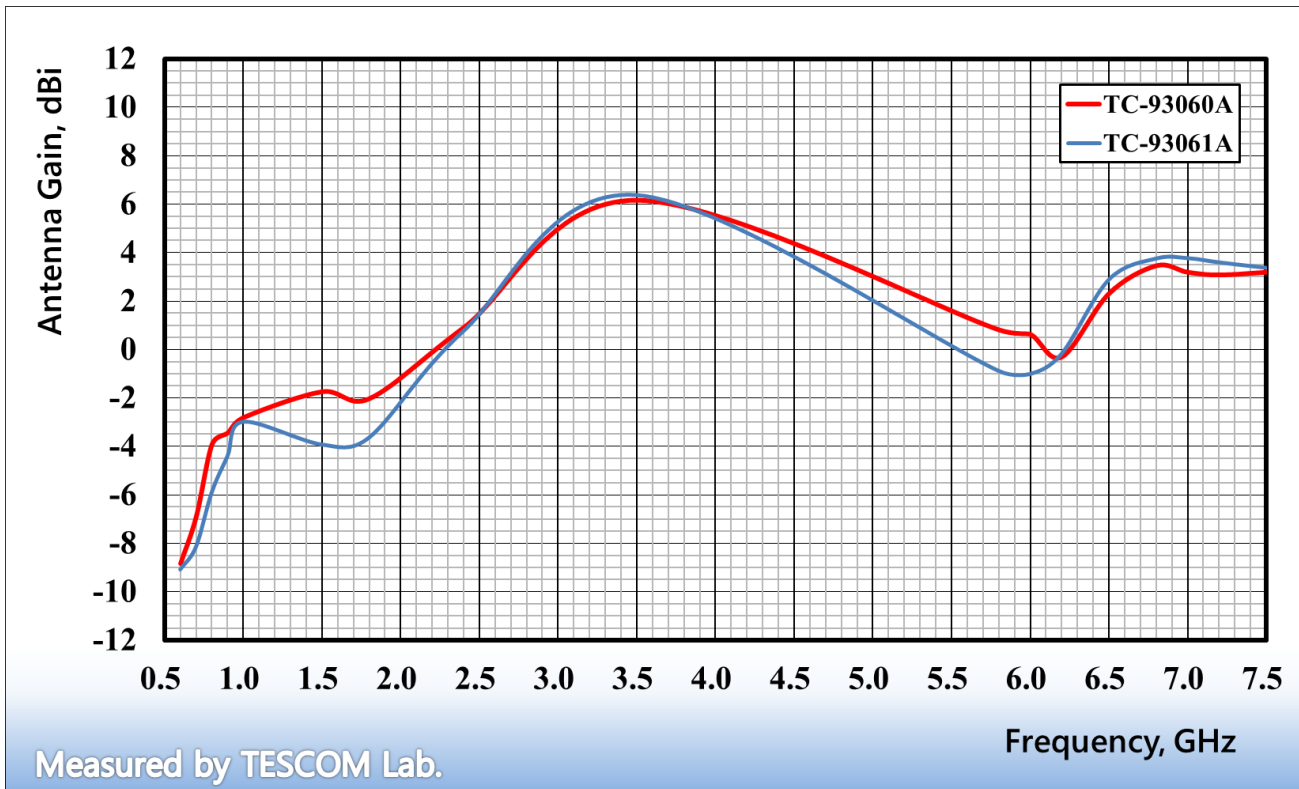

2D Radiation Pattern

TC-93060A

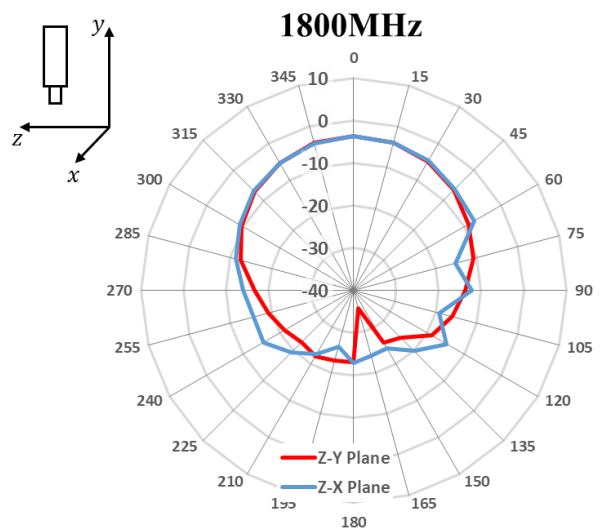
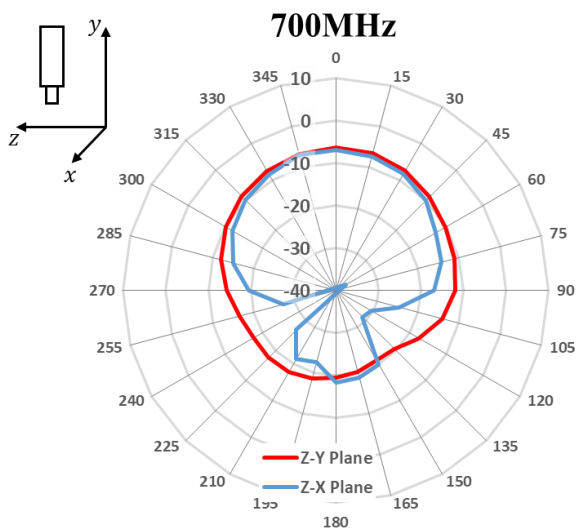

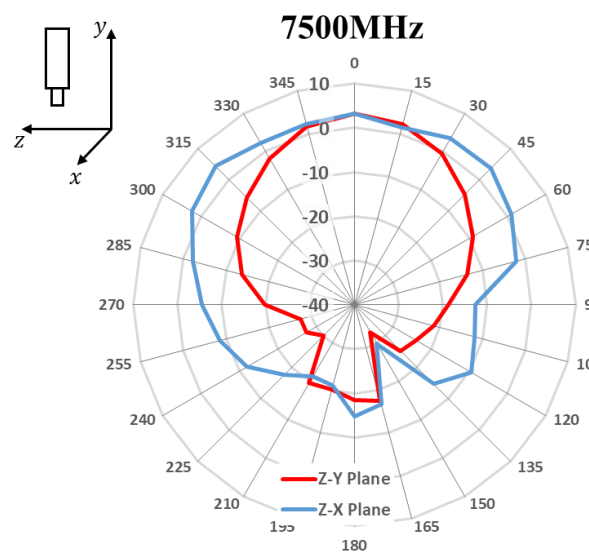
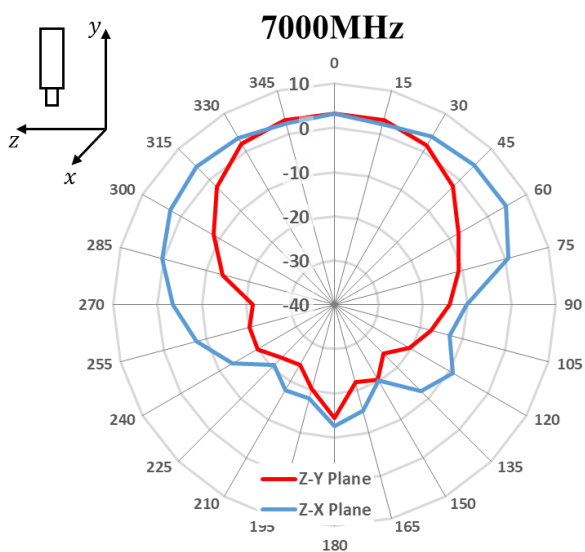
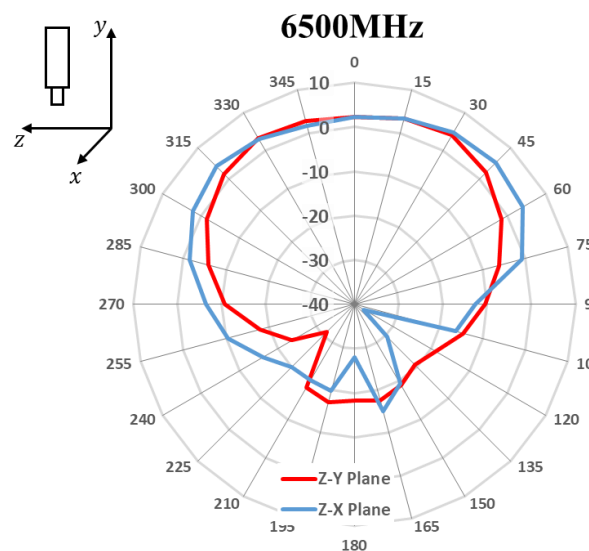
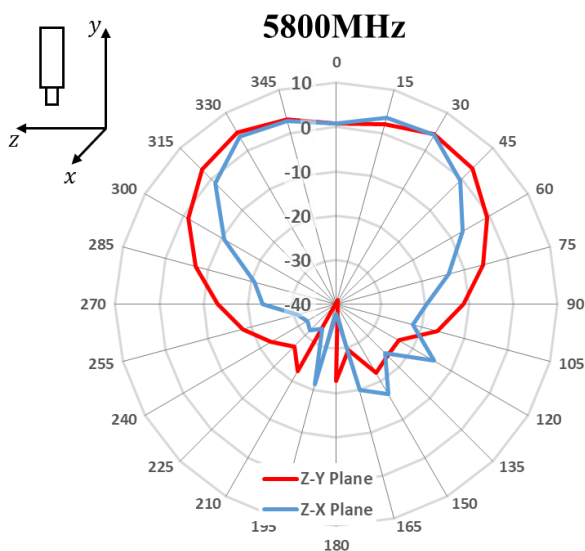
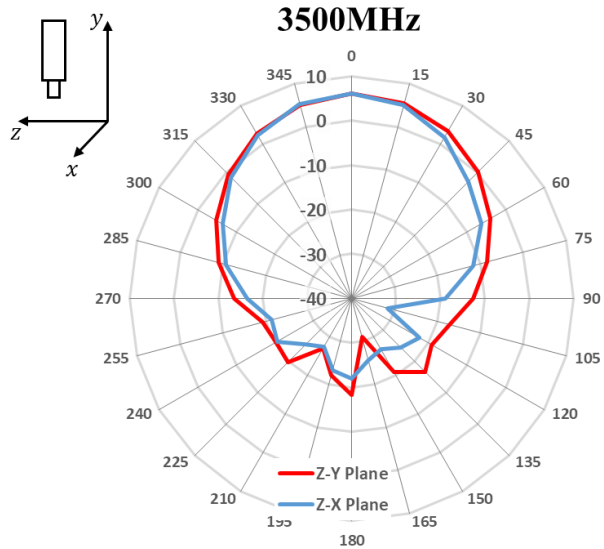
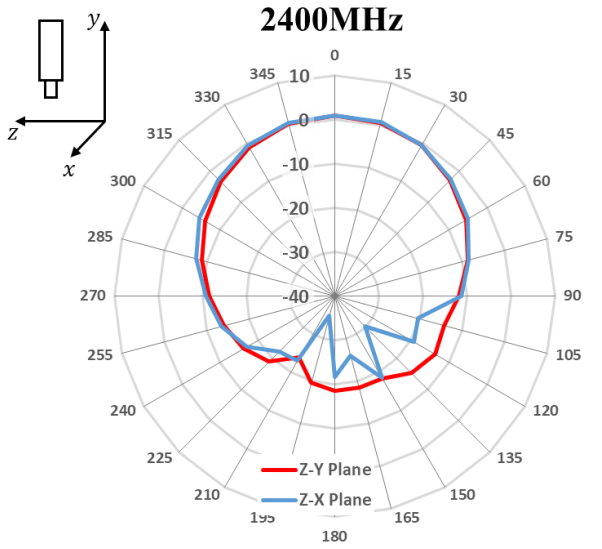

TC-93061A

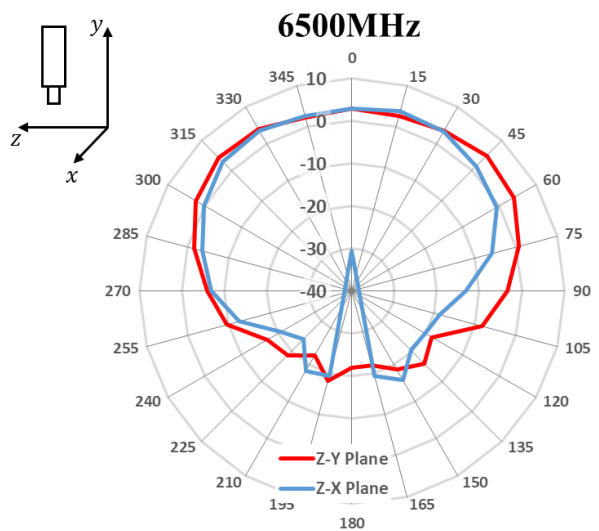
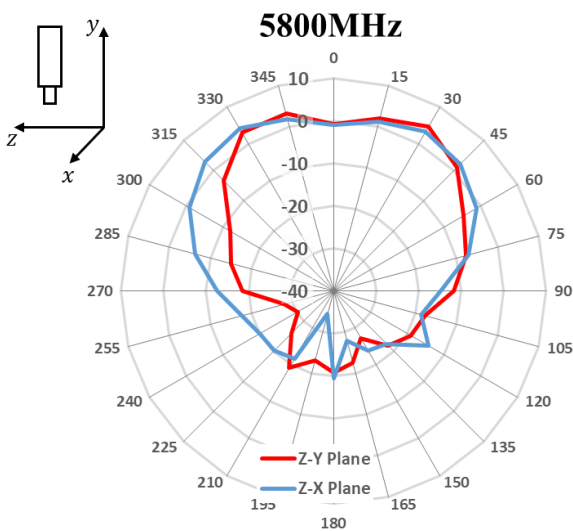
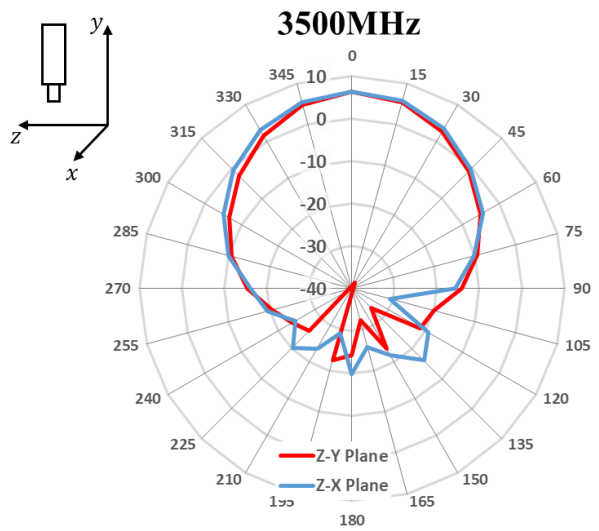
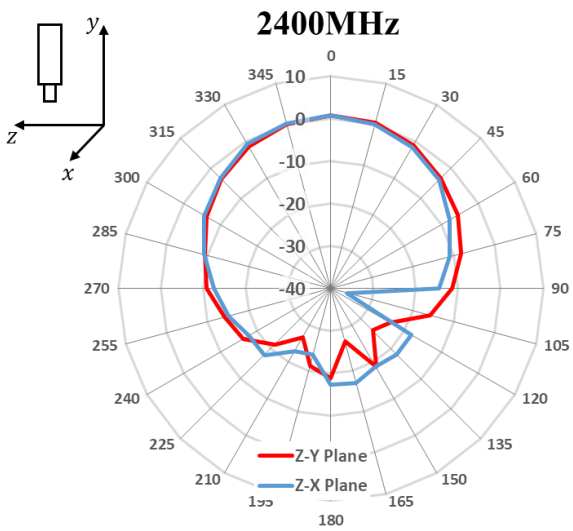
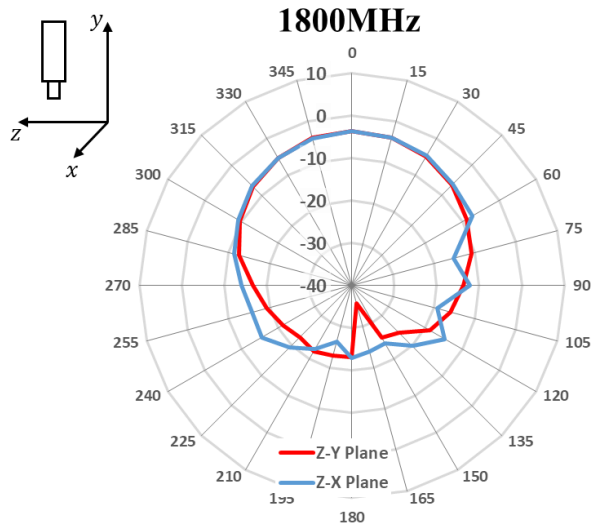
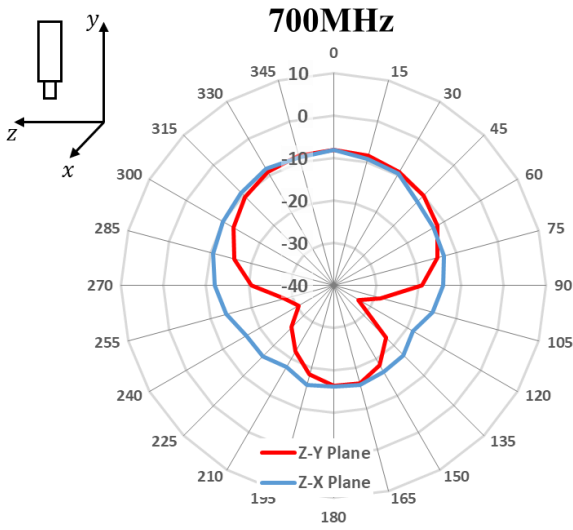

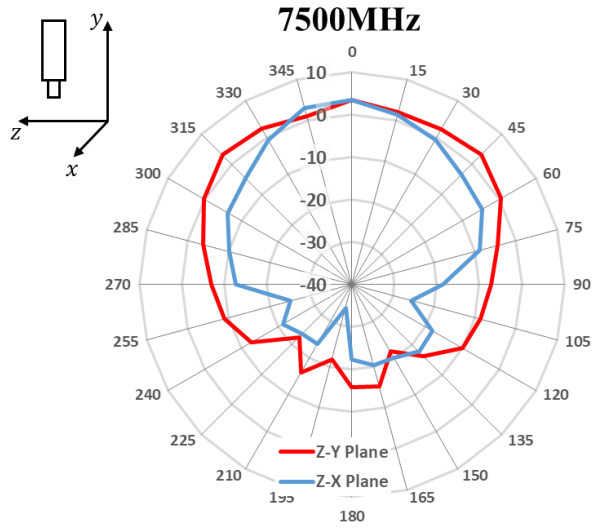
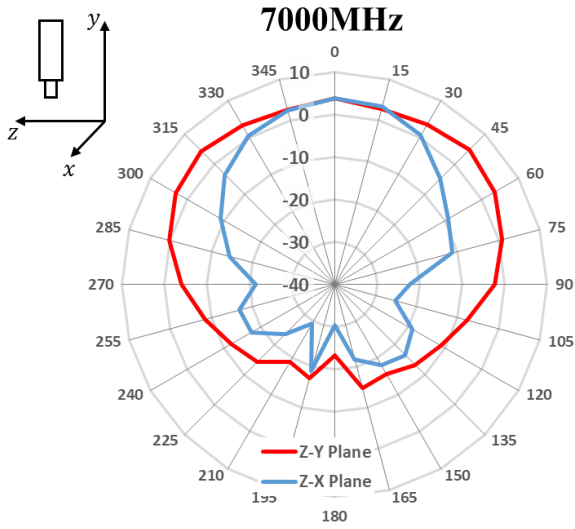

Ordering Information

Order Number	Product
TC-93060A	Antenna Coupler
TC-93061A	(RF Cables are sold separately)

SPECIFICATIONS SUBJECT TO CHANGE WITHOUT PRIOR NOTICE