



Concentric Technology Solutions Inc

Solutions for the Wireless Industry

TC-93065A Antenna Coupler

Specifications



Frequency Range	700 ~ 6000 MHz
RF Connector	SMA(f)
Dimension	136(W) x 136(D) x 13(H) mm
Weight	375 g
Terminal	50 ohm
VSWR	< 2.8 @ 700MHz ~ 6000MHz
Polarization	Right Hand Circular Polarization (RHCP)



Dimensions (Unit : mm)

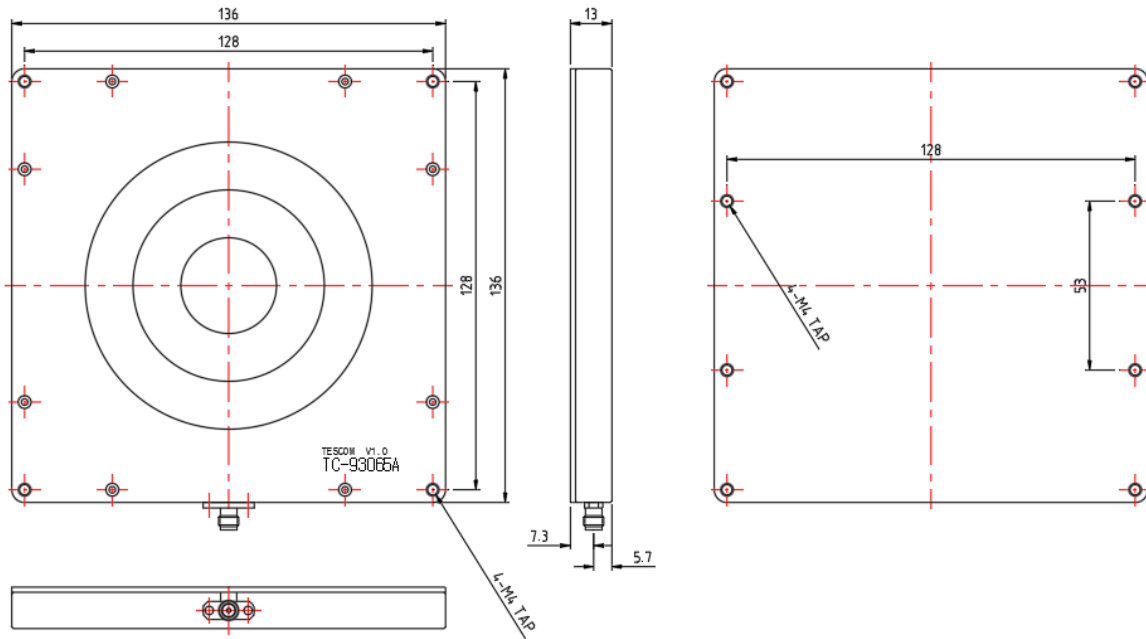

Typical Performance Data

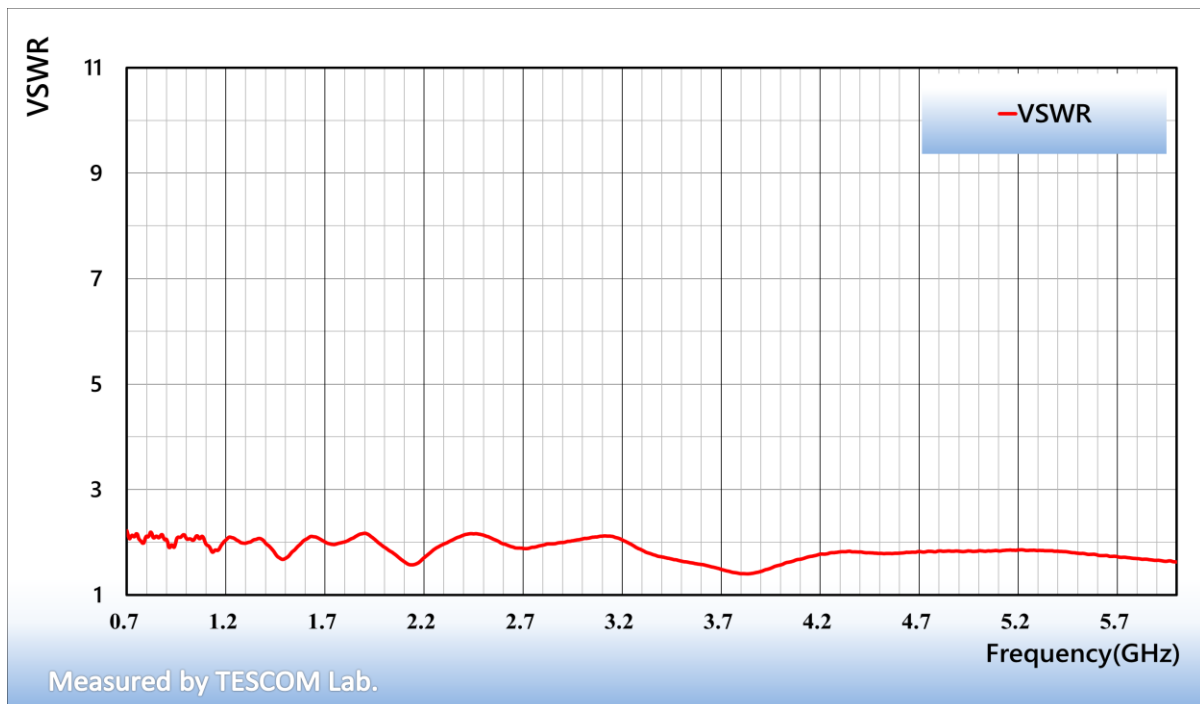



2D radiation pattern

700MHz

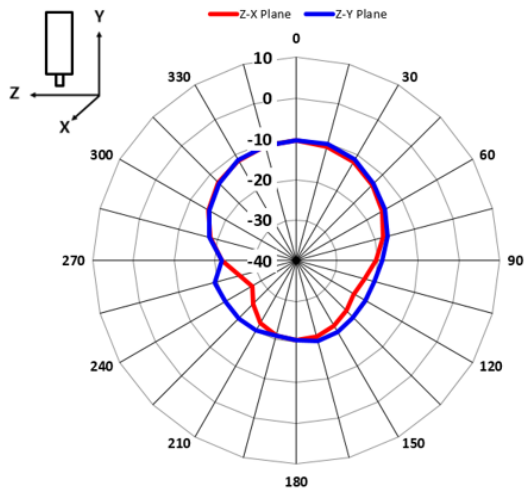

900MHz

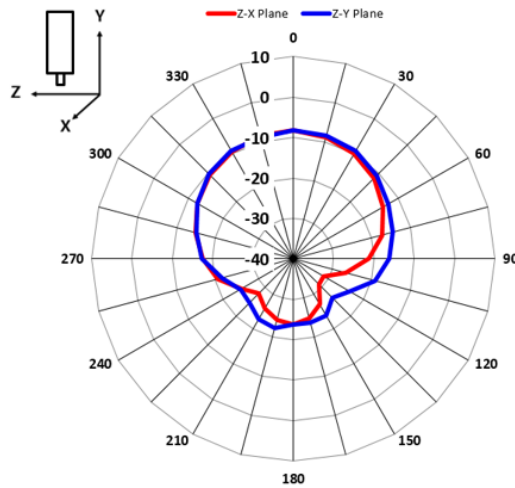

1800MHz

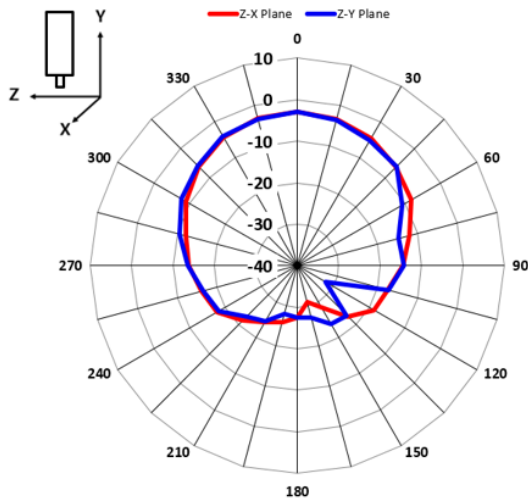

2400MHz

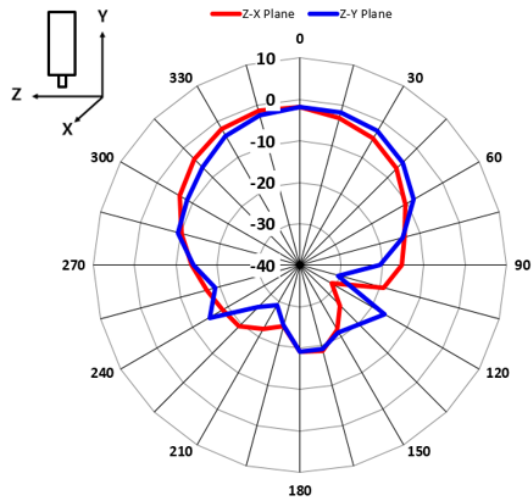



3500MHz

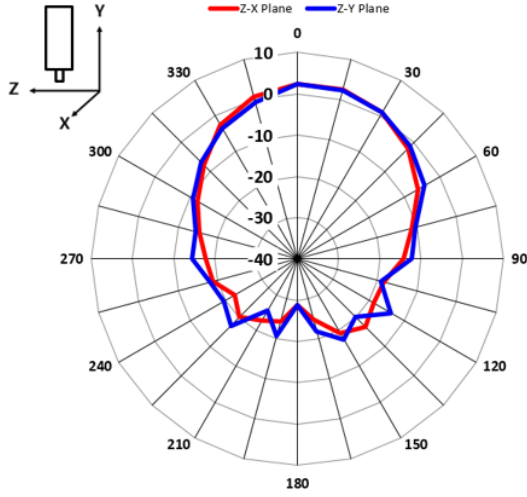

5800MHz

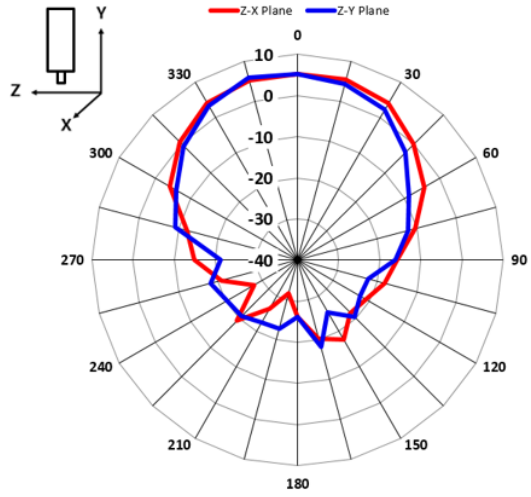

Ordering Information

Order Number	Description
TC-93065A	Antenna Coupler
	RF cables are sold Separately

SPECIFICATIONS SUBJECT TO CHANGE WITHOUT PRIOR NOTICE