



Concentric Technology Solutions Inc

Solutions for the Wireless Industry

TC-93043A

Flat Type Antenna Coupler

Data Sheet



TC-93043A Flat Type Coupler



Front View



Side View

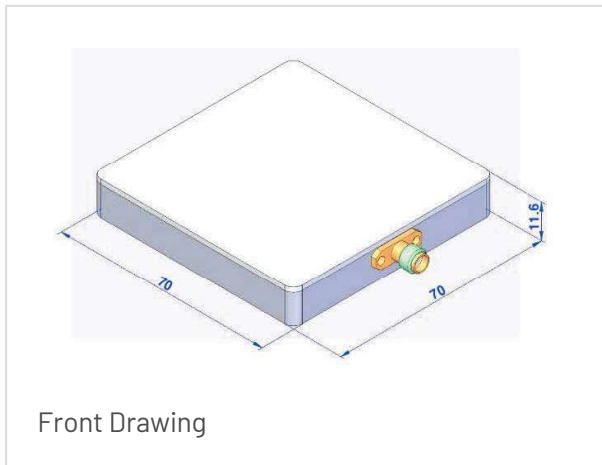

Front Drawing

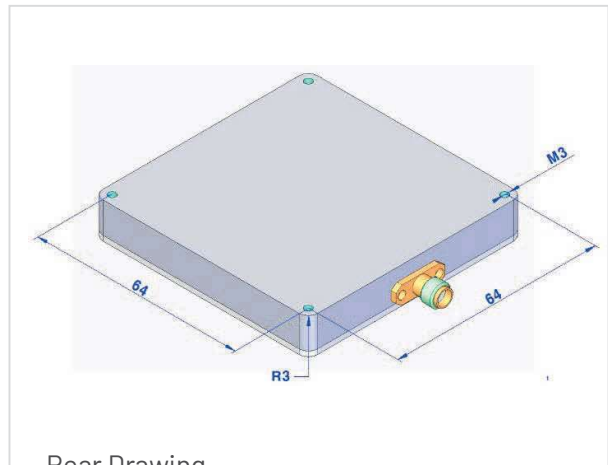

Rear Drawing

Mechanical Specifications

Frequency Range	2 GHz - 7.5 GHz
RF Connector	SMA(f)
Dimension	70 (W) x 70 (D) x 11.6 (H) mm
Norminal Impedance	50 ohm
VSWR	< 2.2



Typical VSWR of TC-93043A

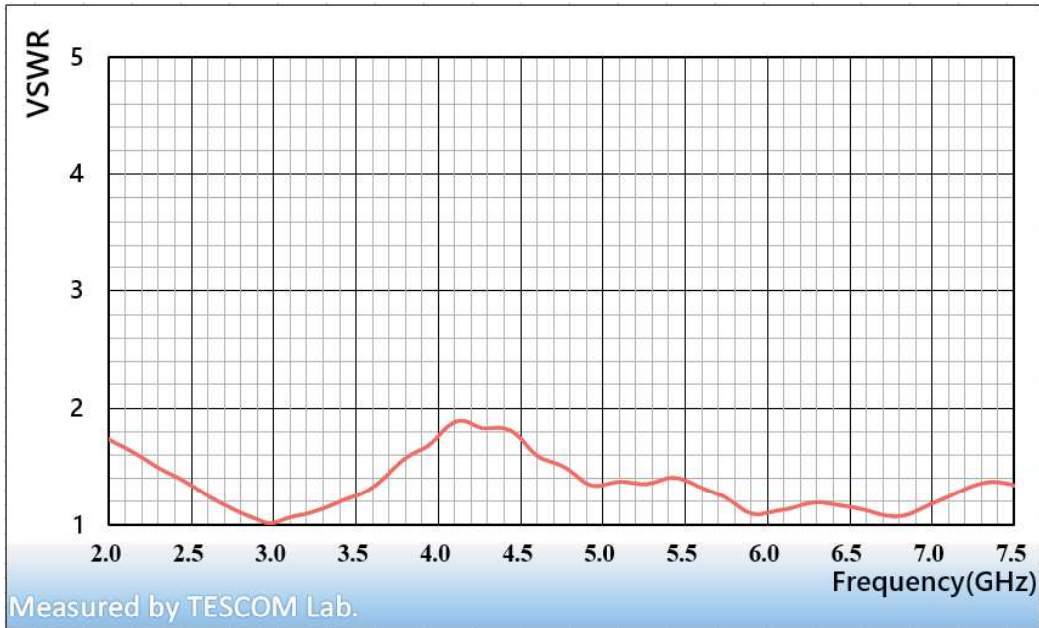

TC-93043A Path Loss Data

Measuring Path loss(S21) with the Network analyzer between 2 units of TC-93043A (Distance : 1.0 cm)
1 unit of TC-93043A for Reference, 1 unit of TC-93043A for Inspection.

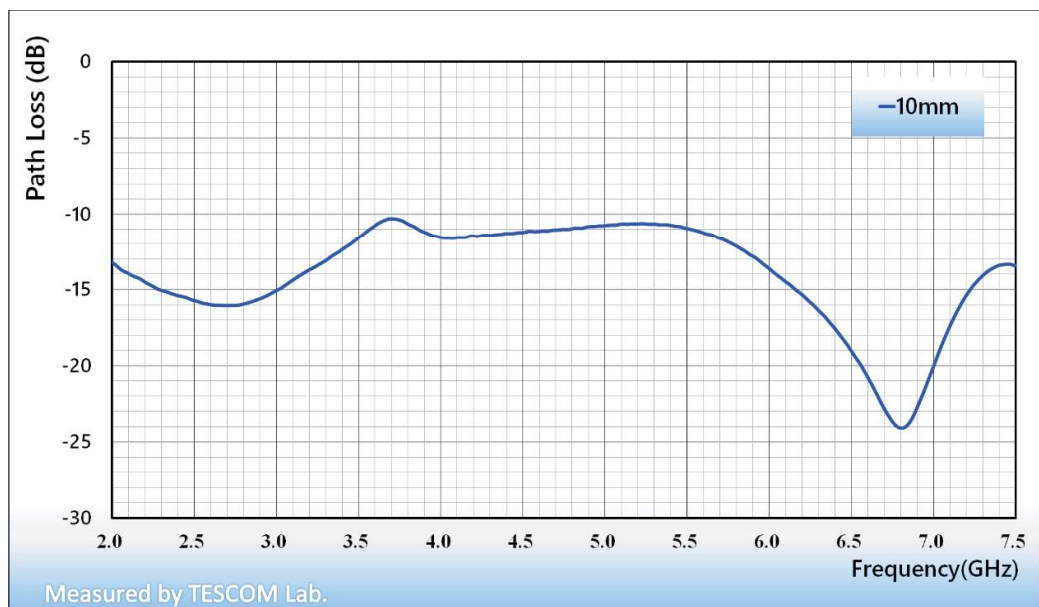
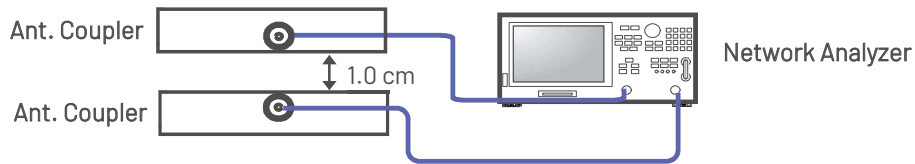



Radiation Pattern

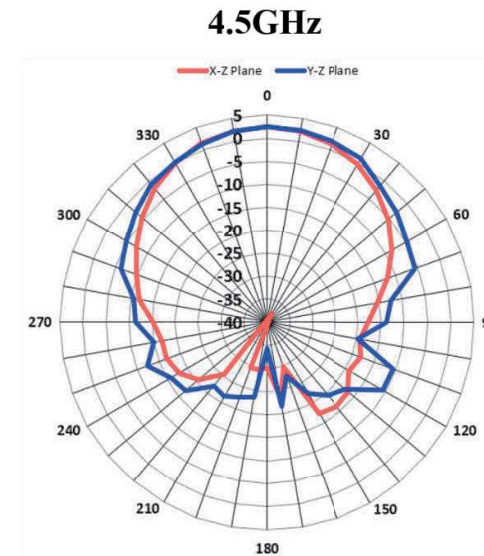
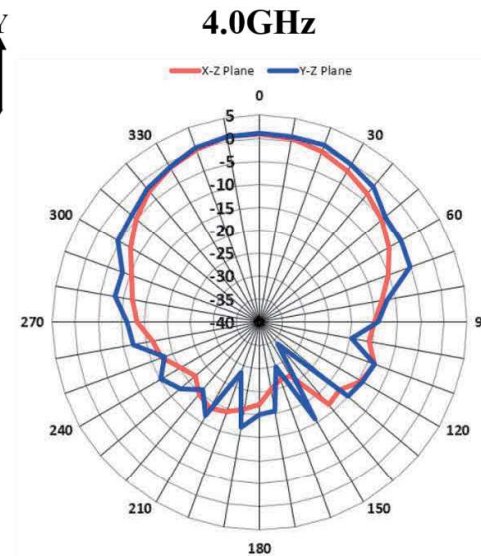
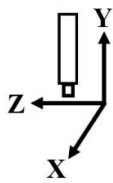
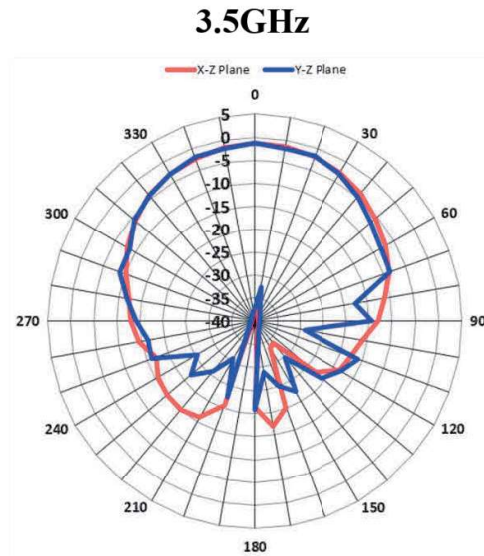
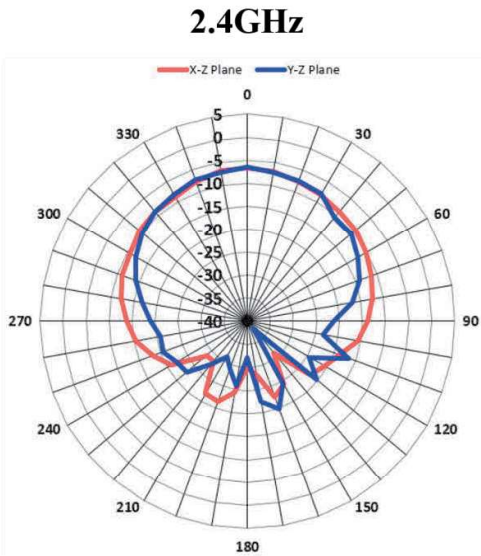
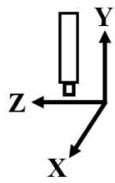

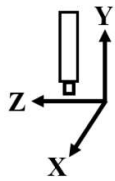

5.0GHz

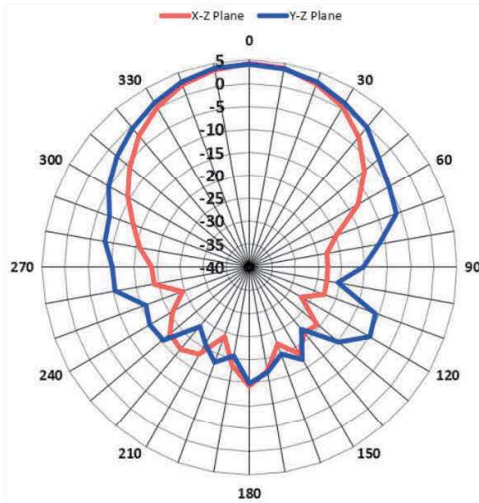

5.5GHz

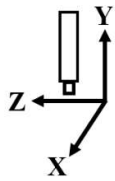
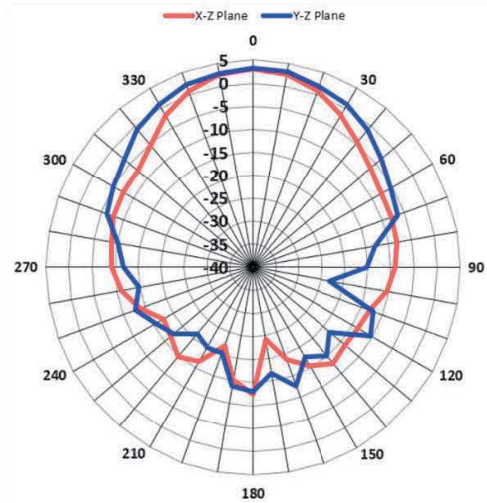

6.0GHz

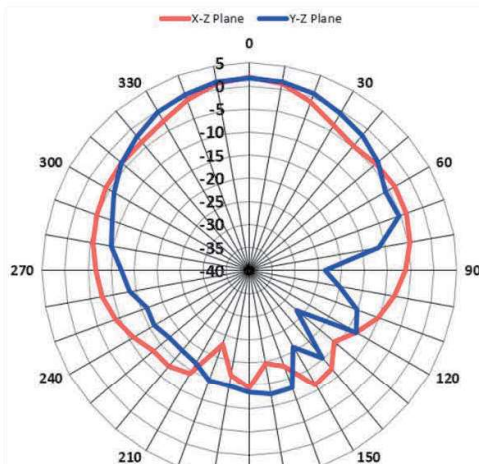

6.5GHz

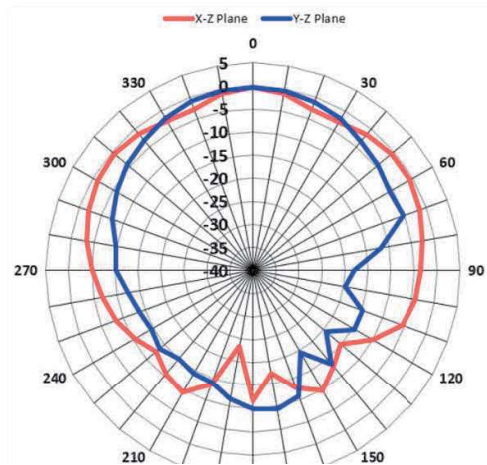

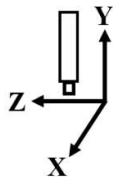

7.0GHz

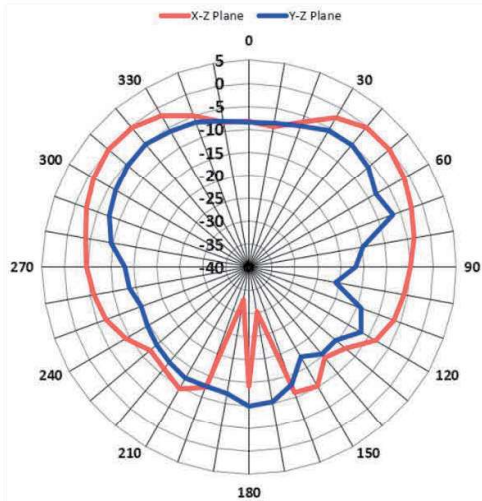

7.5GHz

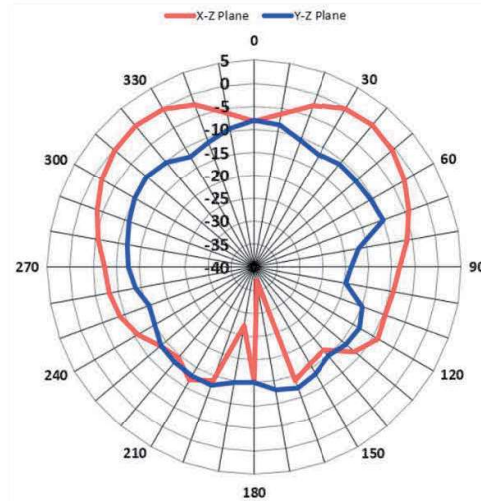

Ordering Information

Order Number	Description
TC-93043A	Flat Type Antenna Coupler (Including accessories below)

RF cables are sold separately

SPECIFICATIONS SUBJECT TO CHANGE WITHOUT PRIOR NOTICE