



Concentric Technology Solutions Inc

Solutions for the Wireless Industry

TC-93083A

Dual Polarized Vivaldi Antenna

Data Sheet

TC-93083A Dual Polarized Vivaldi Antenna

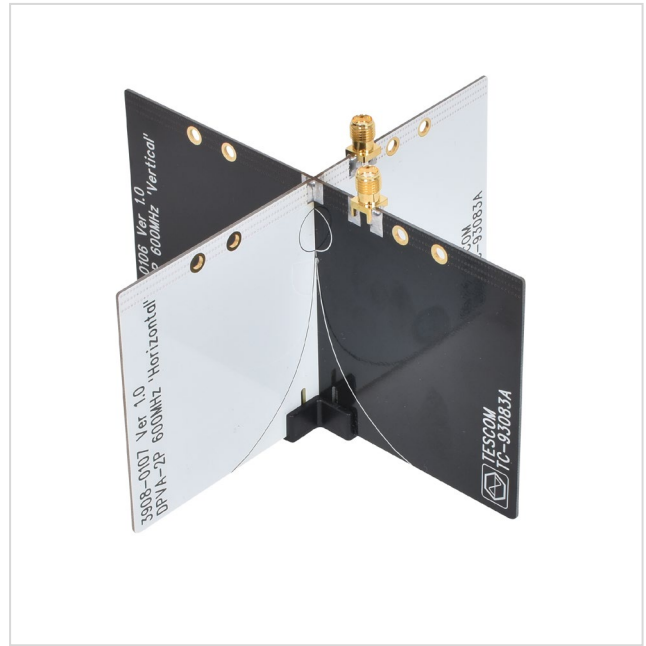
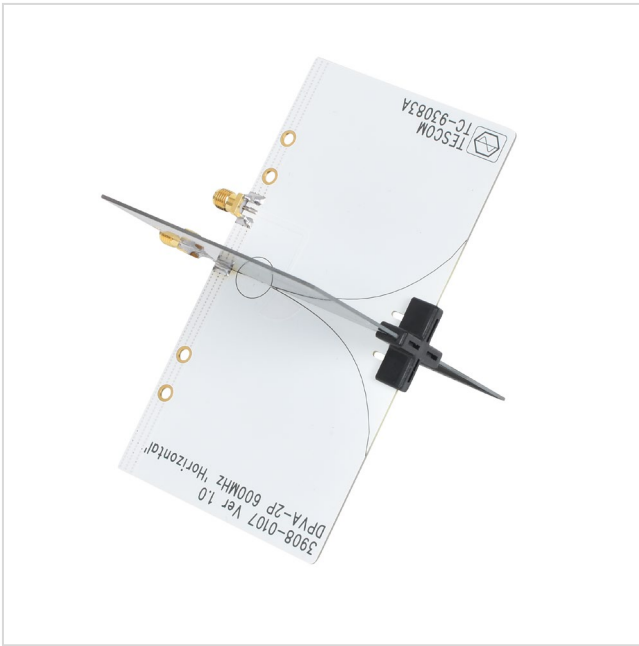

Mechanical Specifications

| | |
|-----------------|--|
| Frequency Range | 0.6 GHz ~ 8 GHz |
| RF Connector | SMA (f) |
| Dimension | 130 (W) x 70 (D) x 1 (H) mm (for Each) |
| Terminal | 50 ohm |
| VSWR | < 3.5 @ 0.6 GHz ~ 8 GHz |
| Antenna Type | DPVA (Dual Polarized Vivaldi Antenna) |

Dimensions

130(W)x70(D)x1(H)mm (for Each) [Unit: mm]

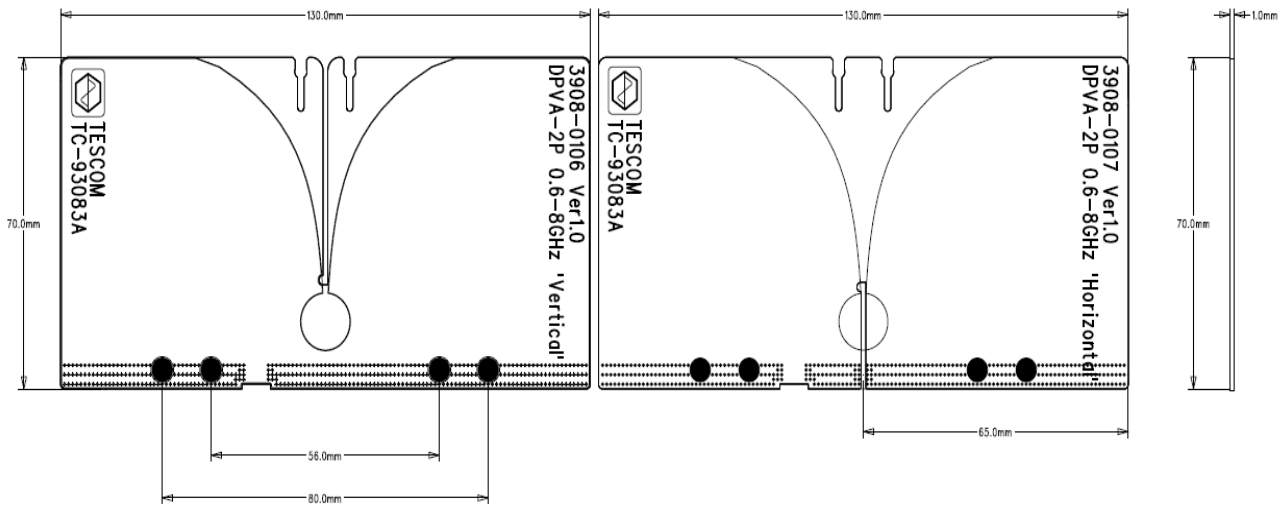

VSWR Data

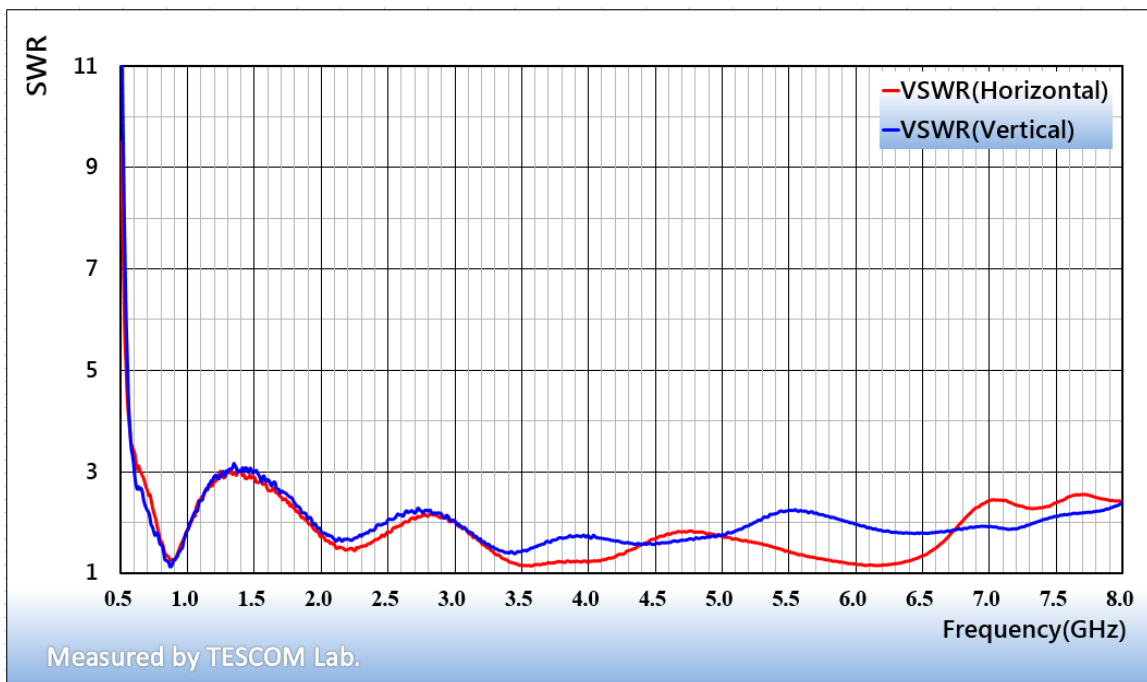

Graph 1. TC-93083A VSWR

Gain Data (Boresight Gain)

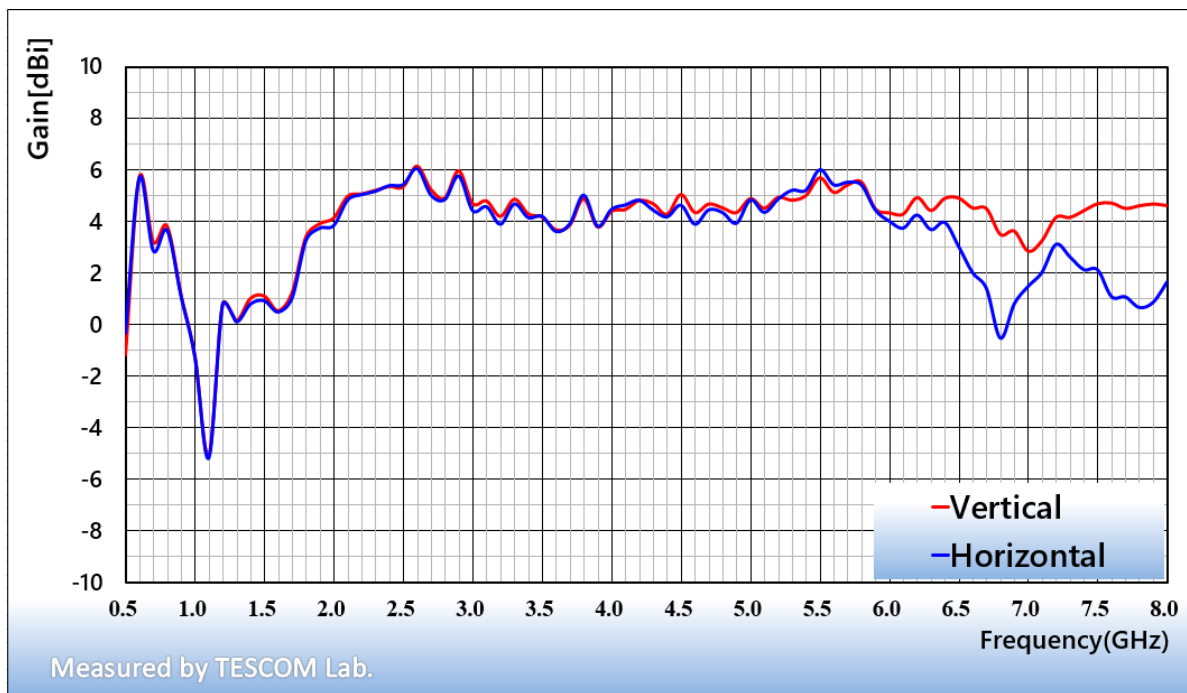

Graph 2. TC-93083A Gain

TC-93083A Path Loss

- Measuring Path loss (S21) with the Network analyzer between 2 units of TC-93083A (Distance: 5 ~ 15 cm)
- 1 unit of TC-93083A for Reference, 1 unit of TC-93083A for Inspection.
-

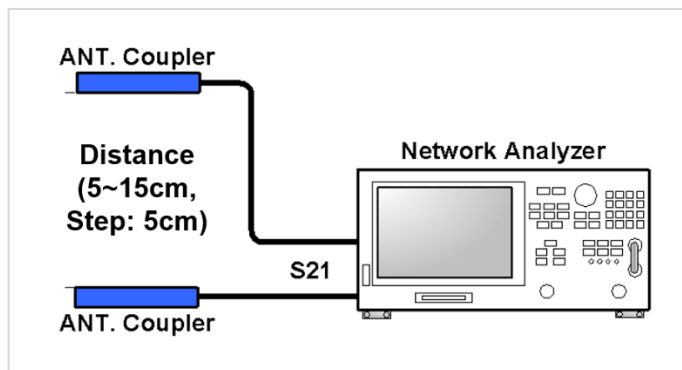

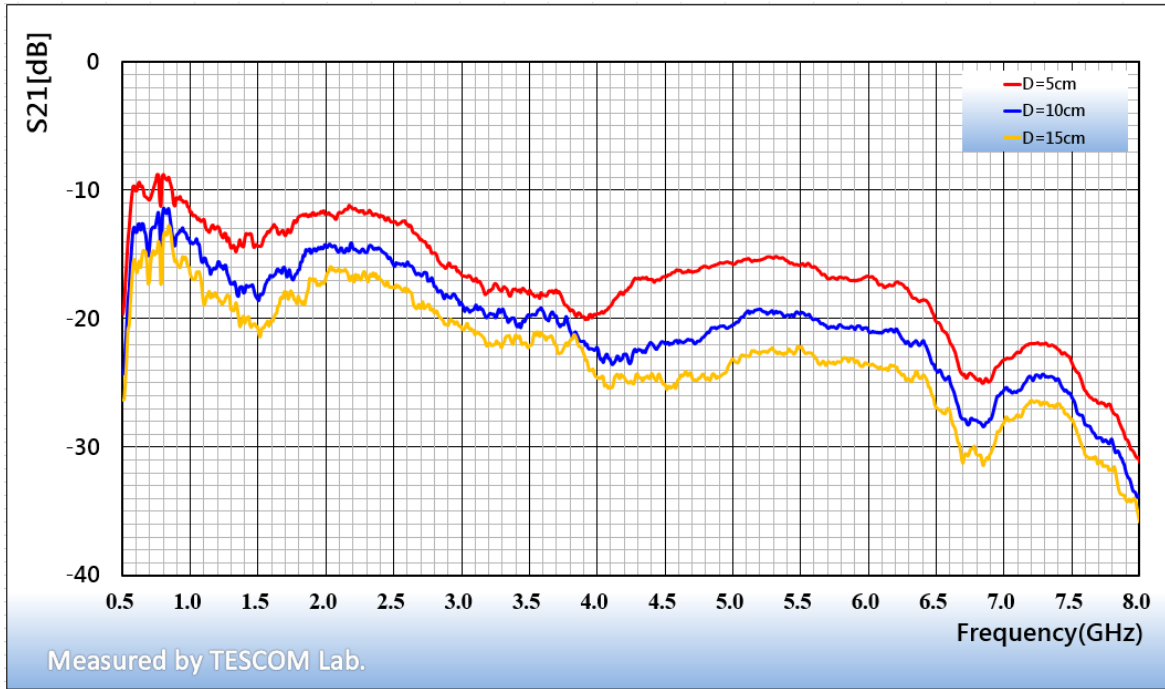

Graph 3. TC-93083A Path-Loss (Horizontal)

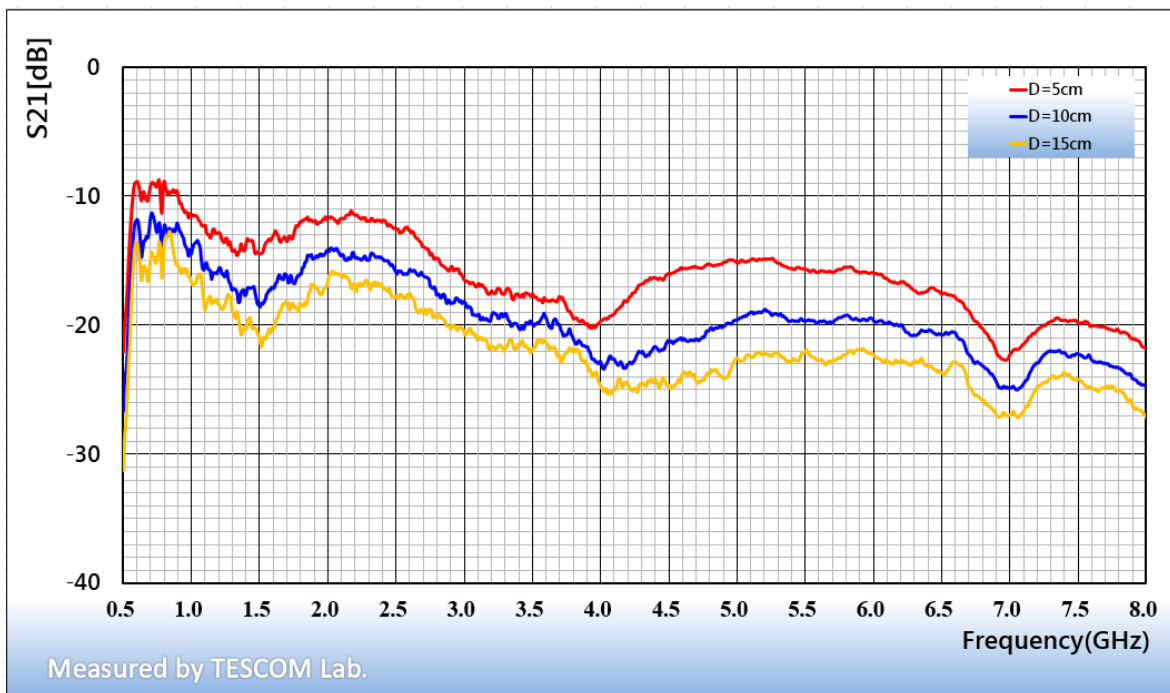

Graph 4. TC-93083A Path-Loss (Vertical)

TC-93083A Radiation Pattern

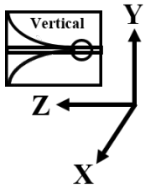

0.6GHz_Vertical

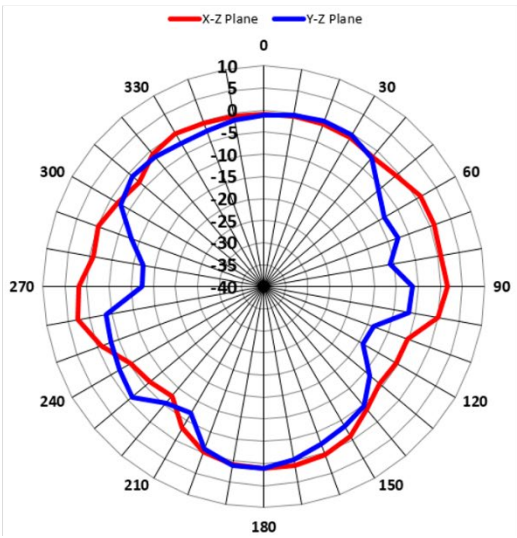

0.6GHz_Horizontal

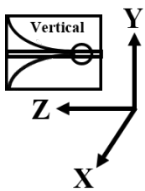
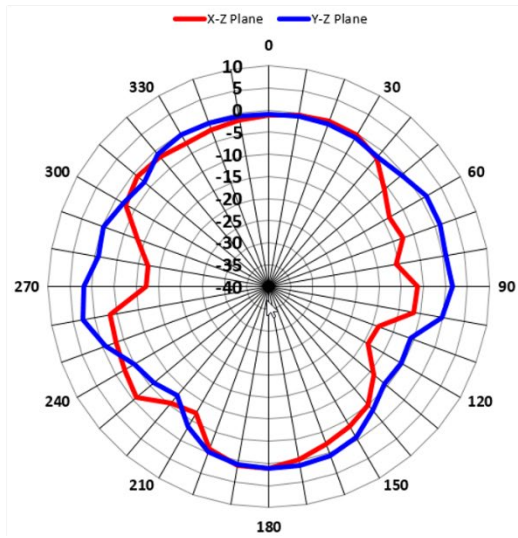

0.9GHz_Vertical

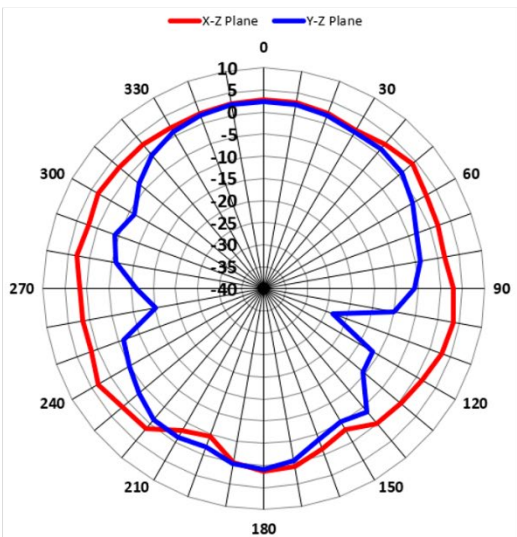

0.9GHz_Horizontal

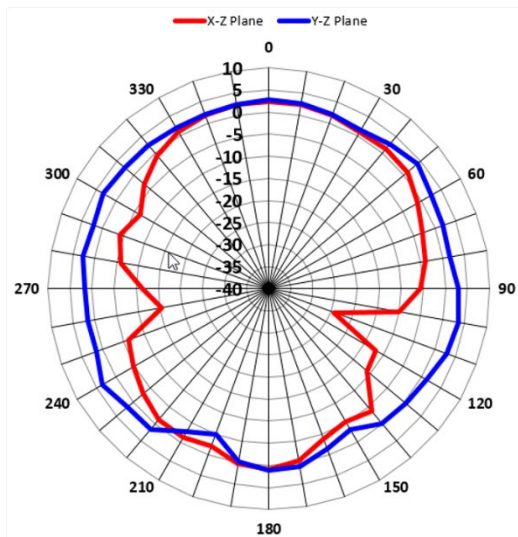

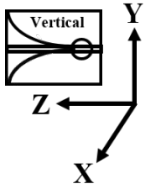

1.8GHz_Vertical

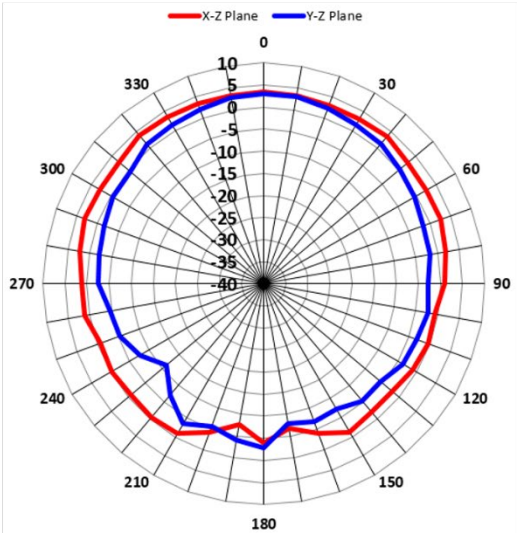

1.8GHz_Horizontal

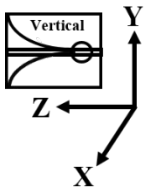
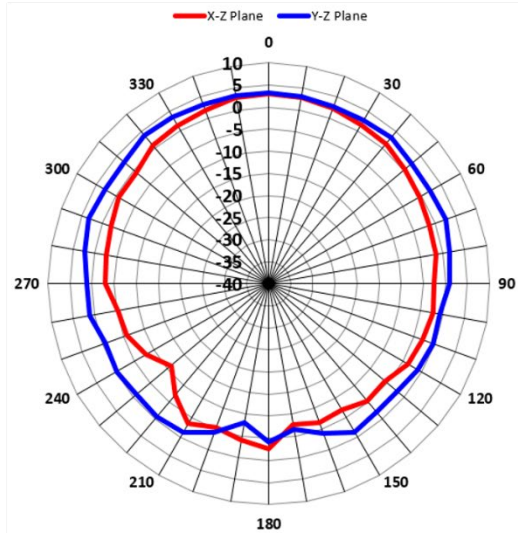

2.4GHz_Vertical

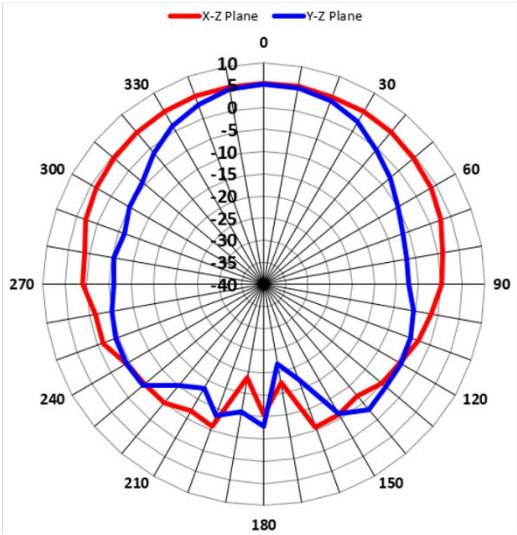

2.4GHz_Horizontal

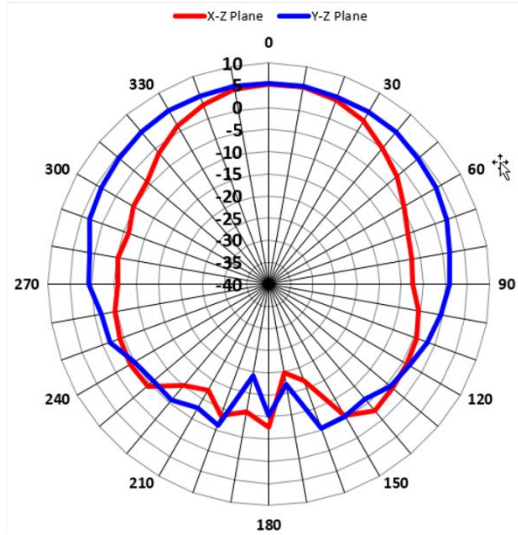

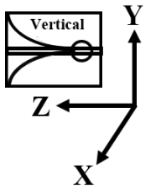

3.5GHz_Vertical

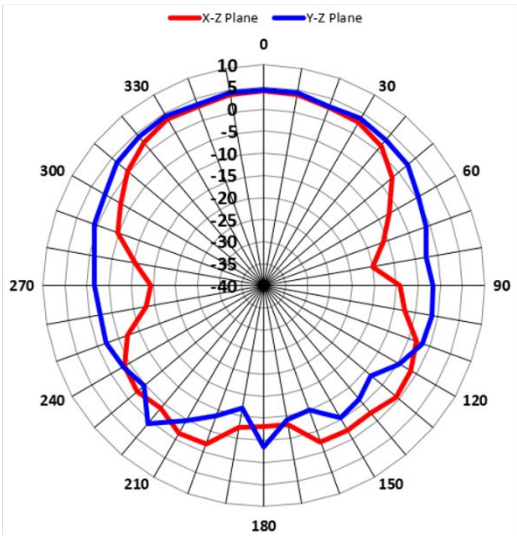

3.5GHz_Horizontal

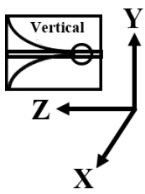
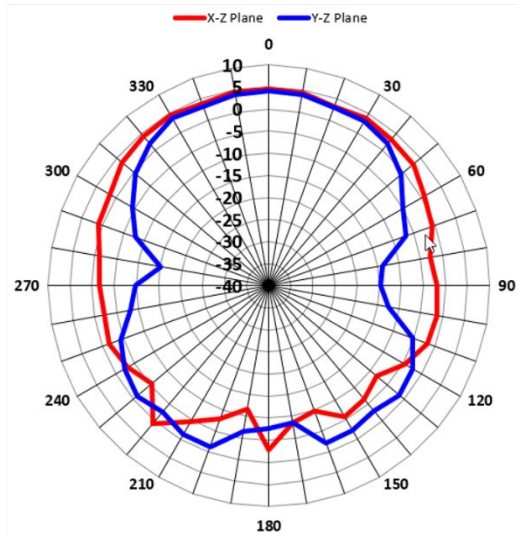

4.0GHz_Vertical

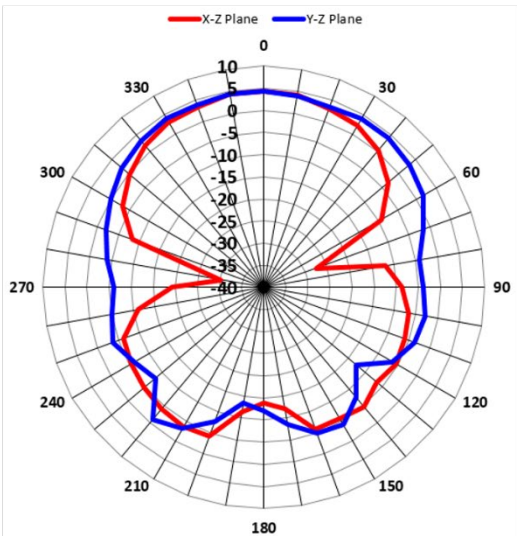

4.0GHz_Horizontal

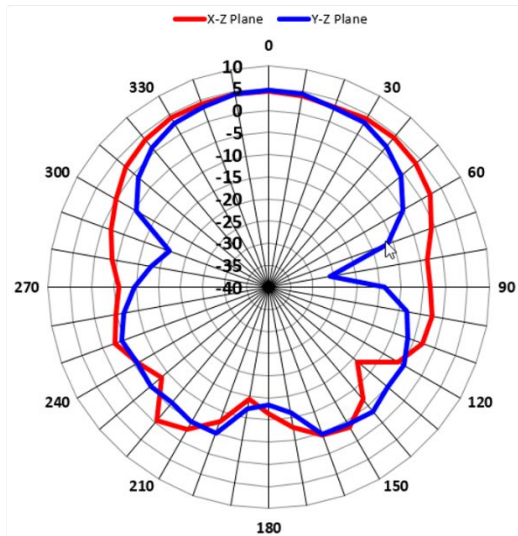

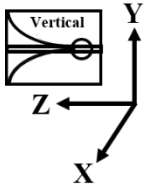

4.5GHz_Vertical

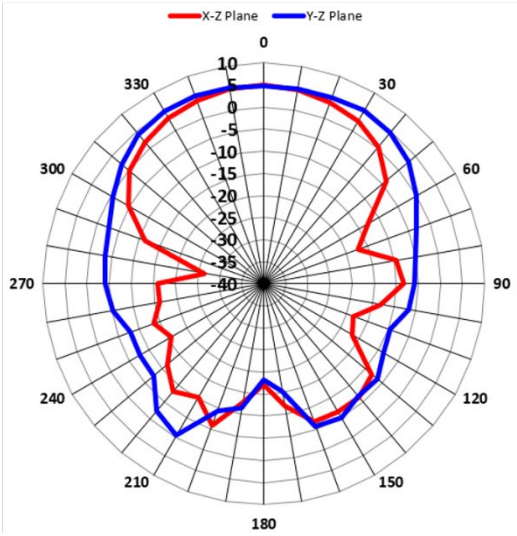

4.5GHz_Horizontal

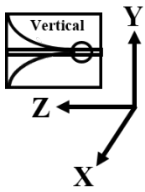
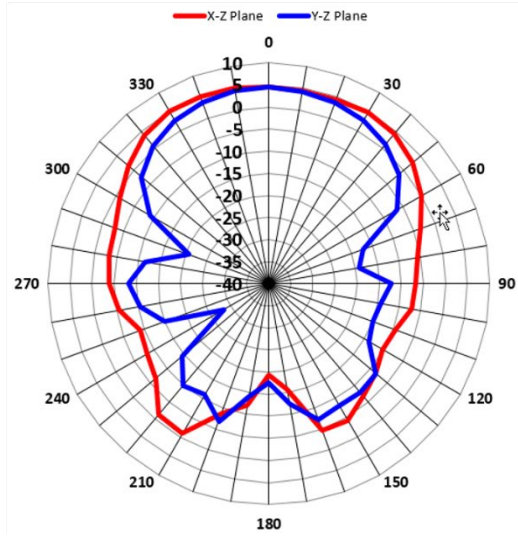

5.0GHz_Vertical

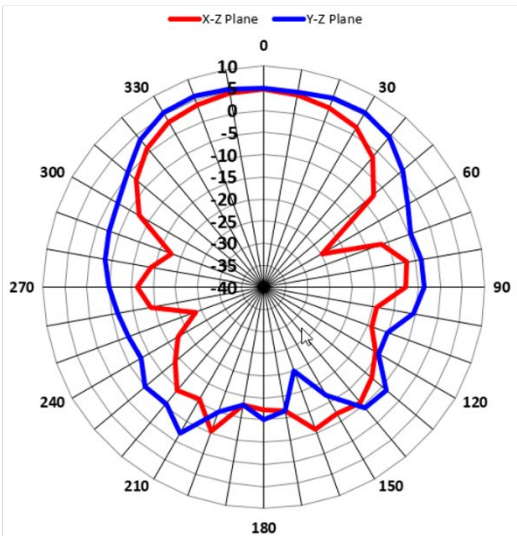

5.0GHz_Horizontal

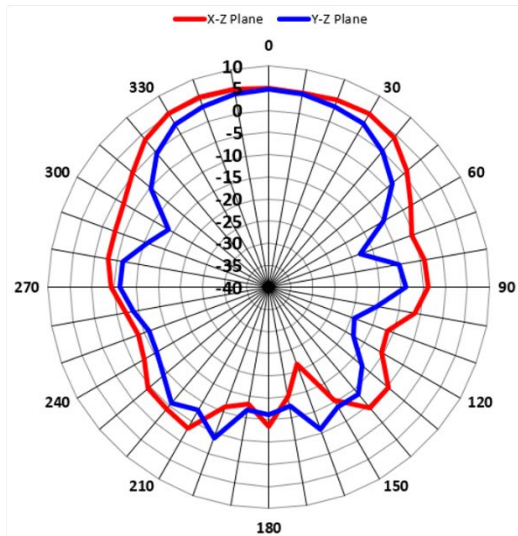

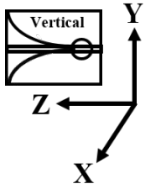

5.5GHz_Vertical

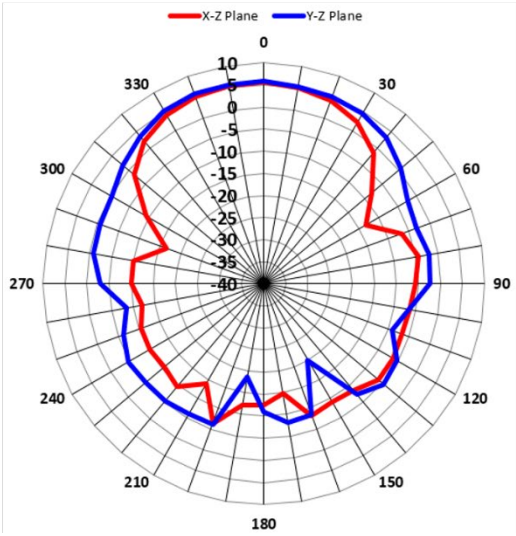

5.5GHz_Horizontal

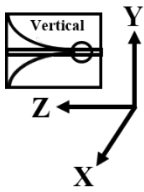
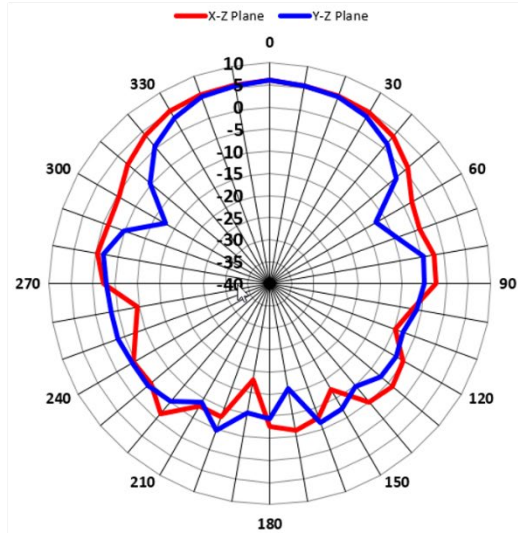

6.0GHz_Vertical

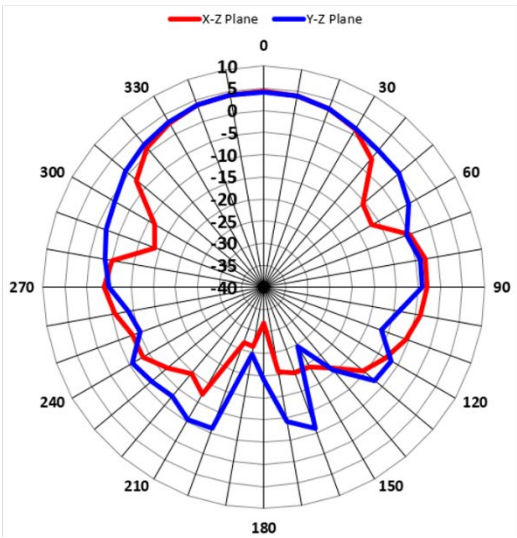

6.0GHz_Horizontal

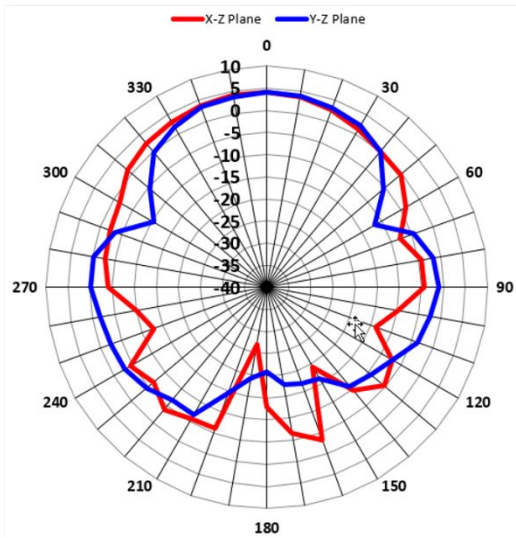

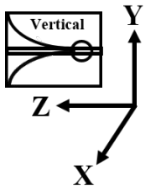

6.5GHz_Vertical

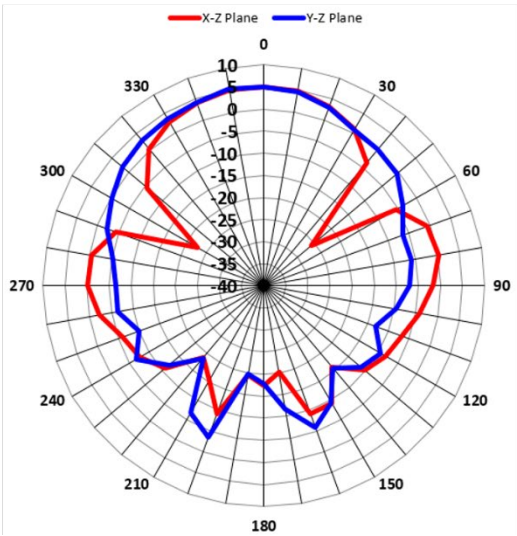

6.5GHz_Horizontal

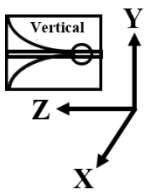
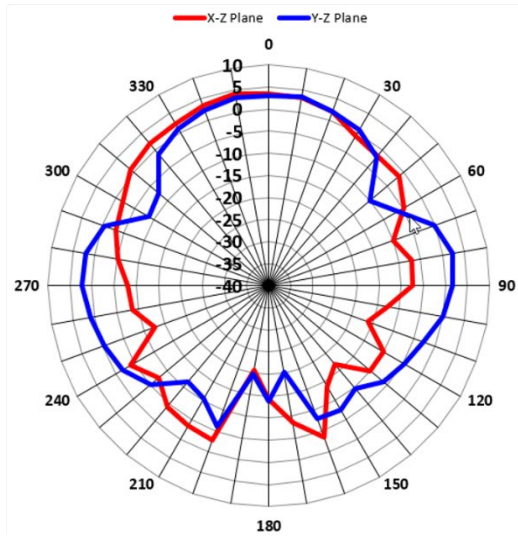

7.0GHz_Vertical

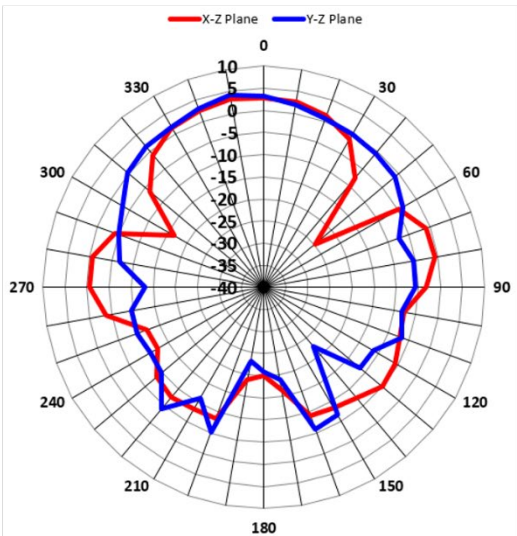

7.0GHz_Horizontal

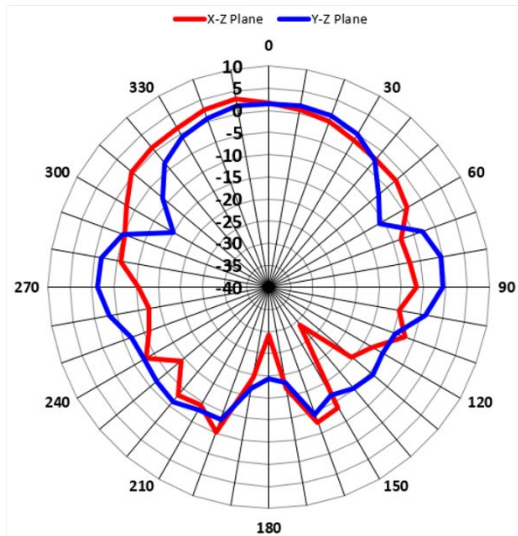

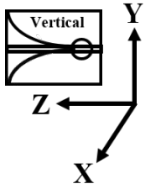

7.5GHz_Vertical

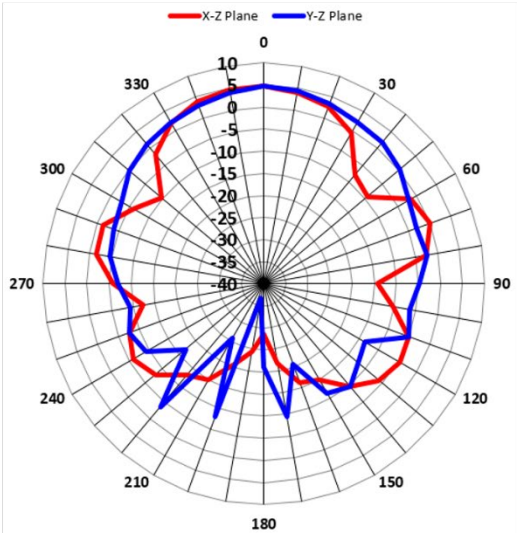

7.5GHz_Horizontal

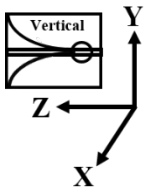
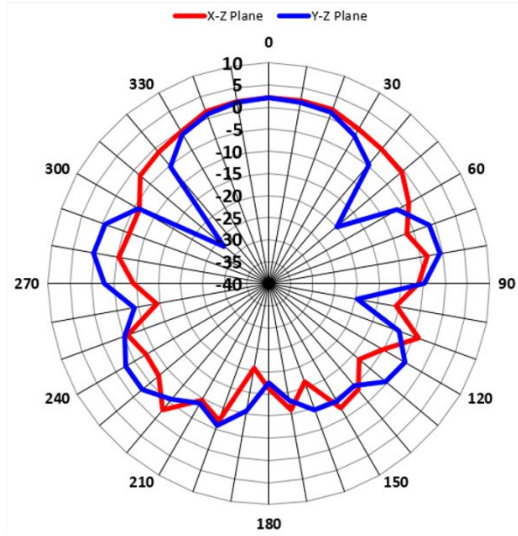

8.0GHz_Vertical

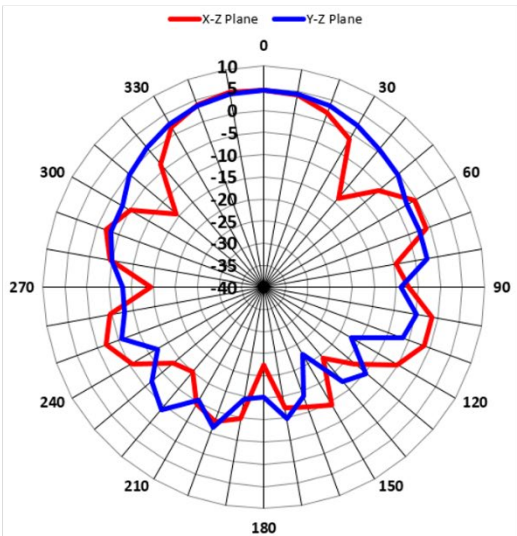

8.0GHz_Horizontal

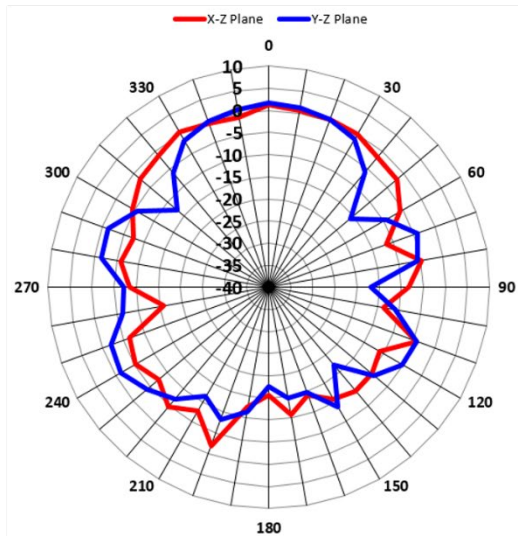

Ordering Information

| Order Number | Description |
|--------------|--|
| TC-93083A | DPV Antenna RF Cables are sold separately. |

SPECIFICATIONS SUBJECT TO CHANGE WITHOUT PRIOR NOTICE

